



www.arfen.com

 **ARFEN**<sup>®</sup>  
"Çözüm Üretir"

Dilatasyon Profilleri / Expansion Joints

CE

ISO 9001:2008



TS BELGELENDİRME  
ISO 9001 : 2008

Çözüm Üretir / Produces Solution





Arfen Ltd 1999 yılında "çözüm üretir" sloganı ile çıktığı yolda 15 yılı aşkın süredir yapı ve sanayi sektörünün ihtiyaçlarına yüksek kalite standartlarında çözüm üretmekte , sadece iç piyasada değil uluslararası pazarlarda da iş ortakları ile birlikte önemli başarılarla imza atmaktadır. Bu başarının altında "kalitede süreklilik ve müşteri odaklı yaklaşım" ilke haline getiren ve bu çizgisinden taviz vermeyen şirket politikası yatmaktadır.

İstanbul Hadımköy ve Çorlu Organizede 12,000 m<sup>2</sup> kapalı alanda faaliyetlerine devam eden Arfen , üretimde ihtisaslaşmayı ilke edinmiş yönetim anlayışı ile plastik ve alüminyum endüstrisinde önemli üreticiler arasına girmiştir. Modern ve teknolojik üretim metodolojisini uygularken iş ve işçi güvenliğine ,insan sağlığına ve çevreye olan duyarlılığını her zaman korumaya özen göstermektedir.

Sürekli yeni yatırım ve geliştirmeler ile yüksek kalite standartları ile üretilen Arfen dilatasyon profilleri, Arfen Köprü genişleme profilleri ve mesnetleri, Arfen dekorasyon profilleri, Viny duvar ve köşe koruma sistemleri, Flymat paspas sistemleri , Hydroflex dilatasyon ve pah bantları ile yapı sektörünün ihtiyaçlarına cevap vermektedir.

Sadece yurt içinde değil 30 ülkede sayısız projelere imza atılmıştır. Arfen çatısı altında üretilen ürünler uzun yıllar sorunsuz şekilde kullanılmaktadır

Kusursuzluk ve kalitede mükemmellik ile birlikte sağlanan müşteri memnuniyeti en önemli hedefimizdir. Bu hedefimize ulaşmak için çalışanlarımızı, müşterilerimizi ve tedarikçilerimizi iş ortağımız olarak görür ve kendilerine teşekkür ederiz.

Saygılarımızla,  
ARFEN

ARFEN Company established in 1999, started its journey with a very strong and challenging motto "building solutions" . We are dedicated to producing high standard quality solutions mainly for high-tech Construction industry. We are not confined to domestic market we have completed very successful projects outside Turkey with our business partners. Our continuous dedication to quality and customer satisfaction are the main drivers of this achievement.

Continuing its activities in a total of 12,000 square meter closed area in Corlu and Hadımköy -TURKEY. Arfen is an important manufacturer in the Plastic and Aluminium industries While implementing modern and advanced production technology, we also give special importance to health and safety of our employees, as well as environmental protection.

Arfen products meet various needs of construction industry Expansion Joint Profiles, Bridge Expansion Joints and Bearings, , Decoration Profiles , Wall&Corner Guard Systems, Movement Control joints, Entrance Matting Systems, dilatation and chamber band with high quality standards and continuous investments and improvements are examples of our large product range

We have our footprints in numerous projects not only in domestic market also in 30 countries. Products manufactured by Arfen , have been used many years without any problems.

Customer satisfaction with high quality production implementation and service is the highest priority for Arfen. To achieve this goal we see our customers, suppliers and employees as a our business partners and indispensable building blocks of our company

Kindest Regards  
ARFEN

Diğer Ürünlerimiz,  
Our Products,



Köprü Genleşme Derzleri  
Bridge Expansion Joints



Elastomerik Mesnetler  
Elastomeric Bearings



Duvar ve Köşe Koruma Sistemleri  
Wall and Corner Guard Systems



Dekorasyon Profilleri  
Decoration Profiles



Alüminyum Gövdeli Paspas Sistemleri  
Entrance Matting Systems

Isıl Genleşme Derz Profilleri Movement Joint Profiles		Isıl Genleşme Derz Profilleri Movement Joint Profiles	Sayfa Page	<b>03</b>
3 CM Dilatasyon Profilleri 3 CM Expansion Joints		3cm Zemin Dilatasyon Profilleri 3cm Expansion Joint Profiles For Floor	Sayfa Page	<b>05</b>
		3cm Duvar Tavan Dilatasyon Profilleri 3cm Wall and Ceiling Expansion Joint Profiles	Sayfa Page	<b>08</b>
5 CM Dilatasyon Profilleri 5 CM Expansion Joints		5cm Zemin Dilatasyon Profilleri 5cm Expansion Joint Profiles For Floor	Sayfa Page	<b>12</b>
		5cm Otopark Zemin Dilatasyon Profilleri 5cm Expansion Joint Profiles For Car Park	Sayfa Page	<b>18</b>
		5cm Duvar Tavan Dilatasyon Profilleri 5cm Wall and Ceiling Expansion Joint Profiles	Sayfa Page	<b>20</b>
Kapaklar Covers		Dilatasyon Kapak Profilleri Cover Joint Profiles	Sayfa Page	<b>26</b>
8 CM Dilatasyon Profilleri 8 CM Expansion Joints		8cm Zemin Dilatasyon Profilleri 8cm Expansion Joint Profiles For Floor	Sayfa Page	<b>30</b>
		8cm Duvar Tavan Dilatasyon Profilleri 8cm Wall and Ceiling Expansion Joint Profiles	Sayfa Page	<b>33</b>
10 CM Dilatasyon Profilleri 10 CM Expansion Joints		10cm Zemin Dilatasyon Profilleri 10cm Expansion Joint Profiles For Floor	Sayfa Page	<b>34</b>
		10cm Otopark Zemin Dilatasyon Profilleri 10cm Expansion Joint Profiles For Car Park	Sayfa Page	<b>44</b>
		10cm Duvar Tavan Dilatasyon Profilleri 10cm Wall and Ceiling Expansion Joint Profiles	Sayfa Page	<b>46</b>
15 CM Dilatasyon Profilleri 15 CM Expansion Joints		15cm Zemin Dilatasyon Profilleri 15cm Expansion Joint Profiles For Floor	Sayfa Page	<b>51</b>
		15 - 20cm Otopark Zemin Dilatasyon Profilleri 15 - 20cm Expansion Joint Profiles For Car Park	Sayfa Page	<b>56</b>
		15cm Duvar Tavan Dilatasyon Profilleri 15cm Wall and Ceiling Expansion Joint Profiles	Sayfa Page	<b>58</b>
20 CM Dilatasyon Profilleri 20 CM Expansion Joints		20cm Zemin Dilatasyon Profilleri 20cm Expansion Joint Profiles For Floor	Sayfa Page	<b>60</b>
		20cm Duvar Tavan Dilatasyon Profilleri 20cm Wall and Ceiling Expansion Joint Profiles	Sayfa Page	<b>62</b>
Tam Sızdırmaz Dilatasyon Profilleri Watertight Expansion Joints		5cm Su Yalıtımlı Zemin Dilatasyon Profilleri 5cm Watertight Expansion Joint Profiles For Floor	Sayfa Page	<b>64</b>
		10cm Su Yalıtımlı Zemin Dilatasyon Profilleri 10cm Watertight Expansion Joint Profiles For Floor	Sayfa Page	<b>66</b>
Parapet Detayları Parapet Details		Parapet Detayları Parapet Details	Sayfa Page	<b>68</b>
İzolasyon Yardımcı Ürünler, Denizlik ve Özel Derz Profilleri Isolation Ancillary Products, Windowsill and Special Joint Profiles		İzolasyon Yardımcı Ürünler Auxiliary Products For Isolation	Sayfa Page	<b>70</b>
		Denizlik Profilleri Windowsill Profiles	Sayfa Page	<b>73</b>
		Özel Derz Profilleri Special Rubber Joint Profiles	Sayfa Page	<b>74</b>
Dilatasyon için Yangın İzolasyonu Fire Insulation for Expansion Joint		Dilatasyon için Yangın İzolasyonu Fire Insulation for Expansion Joint	Sayfa Page	<b>75</b>





AR102-030 Zemin Dilatasyon & AR200-030 Duvar - Tavan Dilatasyon Profili Uygulaması



AR802-150 Zemin Dilatasyon & AR801-150 Duvar Dilatasyon Profili Uygulaması



AR823-150 Zemin Dilatasyon Profili Uygulaması



AR309-100 Zemin Dilatasyon Profili Uygulaması

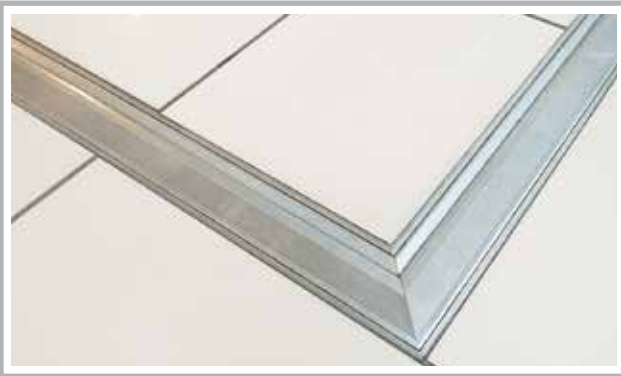

AR713-080 Zemin Dilatasyon Profili Uygulaması



AR600-050 Tam Sızdırmaz Zemin Dilatasyon Profili Uygulaması



AR191-150 Zemin Dilatasyon & AR250 DT Duvar-Tavan Dilatasyon Profili Uygulaması



AR911-051 Zemin Dilatasyon Profili Uygulaması



### Neden genleşme derzleri kullanılır?

Seramik, granit, porselen, taş, camlı seramikler, beton ve mermer karolar, terrazo uygulamaları, birleşmelerinden doğan doğal hareketleri sönmölemek için ısı genleşme derzlerine ihtiyaç duyarlar. Sıcaklık farkı, su veya nem kaplamalarda genleşme ve büzüşmeye sebep olur. Tüm karolar kuruma ve soğuma ile büzülürler. Ayrıca dinamik yapısal yükler karo uygulamalarının titreşimine ve hareketine sebep olurlar. Bu sebeplerden dolayı derz dizaynı kaplamaların ömrü için çok önemlidir. Karo seramik, granit yada mermer uygulamalarında genleşme derzi kullanılmazsa genleşme ve büzülme döngüsü sebebiyle oluşan iç gerilmeler birçok probleme sebep olabilir. Kaplamalarda çatlamalar, kırılmalar meydana gelir.

### Why movement control joints are used?

Ceramic, granite, porcelain, stone, glassy ceramics, concrete and marble tiles, terrazzo applications require thermal expansion joints to absorb natural movements resulting from their assembly. The temperature difference causes expansion and shrinkage in water or moisture coatings. All the tiles shrink with drying and cooling. Dynamic structural loads also cause vibration and movement of tile applications. Because of this, the joint design is very important for the life of the coatings. If expansion joint is not used in tile, ceramic, granite or marble applications, internal stresses due to expansion and contraction cycling can cause many problems. Crackings and crashes can occur in the coatings.



## Alüminyum Isıl Genleşme Derz Profilleri

### Aluminium Movement Joint Profiles

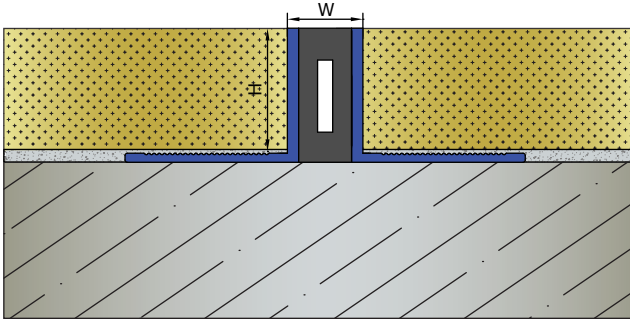

Ürün Kodu Code	Genişlik (W)	Yükseklik (H)	Renk Color	Boy (mt)
DP01-6	10	6,5	Gri, Krem	3,0
DP01-8	10	8,5	Gri, Krem	3,0
DP01-10	10	10,5	Gri, Krem	3,0
DP01-12	10	12,5	Gri, Krem	3,0
DP01-14	10	14,5	Gri, Krem	3,0
DP01-16	10	16,5	Gri, Krem	3,0
DP01-23	10	23,5	Gri, Krem	3,0





## Paslanmaz Isıl Genleşme Derz Profilleri Stainless Steel Movement Joint Profiles

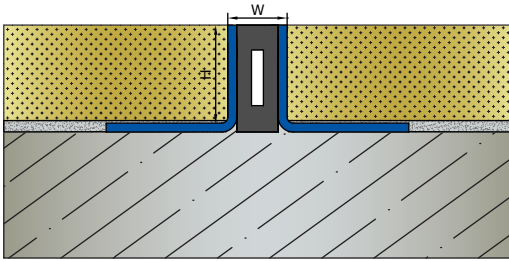

Ürün Kodu Code	Genişlik (W)	Yükseklik (H)	Renk Color	Boy (mt)
DP08-12	10	12,5	Gri, Krem	3,0
DP08-14	10	14,5	Gri, Krem	3,0
DP08-16	10	16,5	Gri, Krem	3,0
DP08-23	10	23,5	Gri, Krem	3,0
DP 11	10	25	Gri, Krem	3,0

## PVC Isıl Genleşme Derz Profilleri PVC Movement Joint Profiles

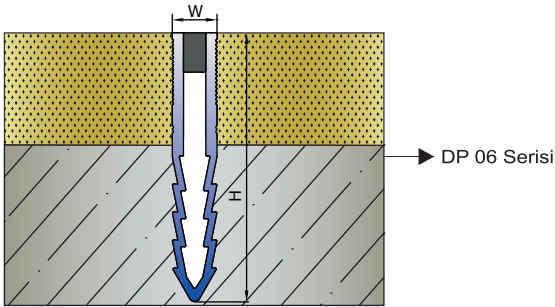

Ürün Kodu Code	Genişlik (W)	Yükseklik (H)	Renk Color	Boy (mt)
DP02-10	8	10,2	Gri, Krem	3,0
DP02-12	8	12,5	Gri, Krem	3,0
DP02-15	8	15	Gri, Krem	3,0
DP 06	8	48	Gri, Krem	3,0
DP06-1	8	35	Gri, Krem	3,0

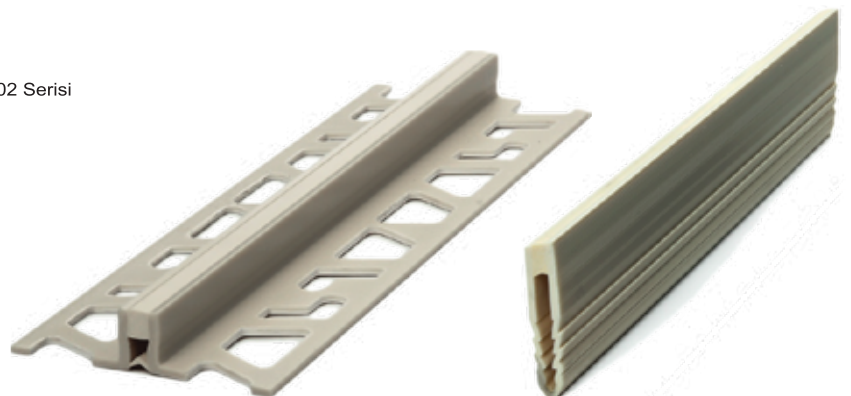
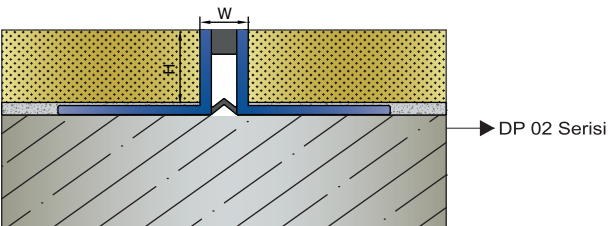

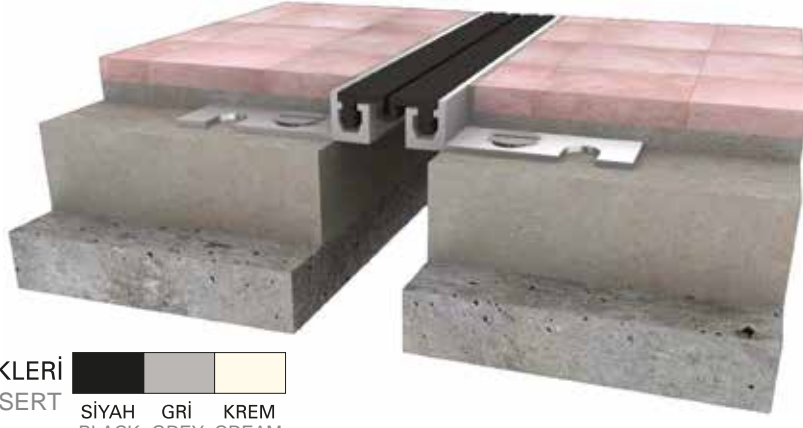

**FİTİL RENKLERİ**  
COLOURS OF INSERT

■	■	■
SIYAH	GRI	KREM
BLACK	GREY	CREAM

Düz fitil alternatifi  
Smooth insert alternative



### AR100-030

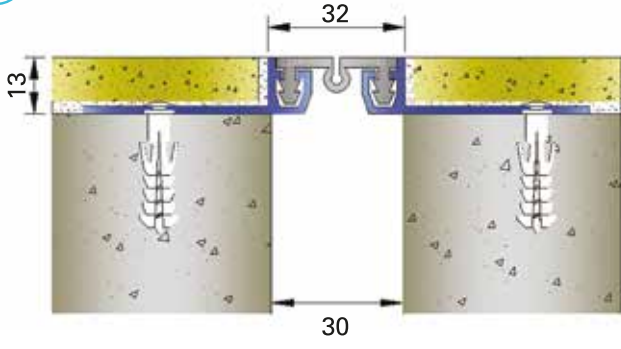

#### AÇIKLAMA / EXPLANATION

Yapıştırma seramik, granit seramik, vb... zeminlere uygun kaplama altı dilatasyon profili  
It is suitable for ceramic, granite ceramic etc.

#### TEKNİK ÖZELLİKLER / TECHNICAL FEATURES

Açıklık : 30 mm  
Width: 30 mm  
Yükseklik : 13 mm  
Height: 13 mm  
Yaya trafiğine dayanıklı  
Resistant to foot traffic  
Hareket Kapasitesi: ± 10mm  
Movement Capacity: ± 10mm  
Profil Boyu: 3mt.  
Profile Length: 3mt.  
Bu profilin h:20mm olanı mevcuttur.  
Height is available 20mm

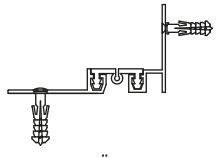

AR100-030 KÖŞE DETAYI  
AR100-030 CORNER DETAIL

### AR101-030

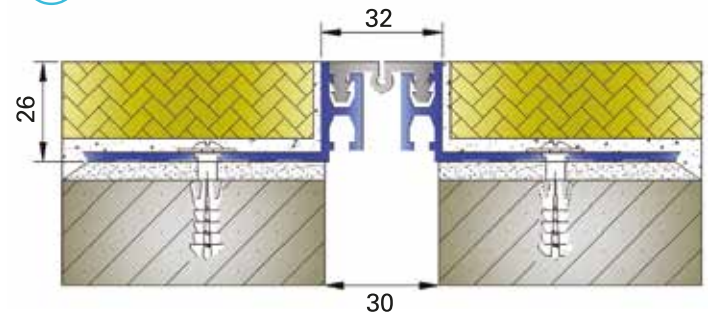

#### AÇIKLAMA / EXPLANATION

Doğal granit, mermer, karo mozaik vs... zeminlere uygun kaplama altı dilatasyon profili  
It is suitable for granite, marble, tile etc.

#### TEKNİK ÖZELLİKLER / TECHNICAL FEATURES

Açıklık : 30 mm  
Width: 30 mm  
Yükseklik : 26 mm  
Height: 26 mm  
2,5 ton araç trafiğine dayanıklı  
Resistant to 2,5 ton of vehicle traffic  
Hareket Kapasitesi: ± 10mm  
Movement Capacity: ± 10mm  
Boyu: 3mt.  
Profile Length: 3mt

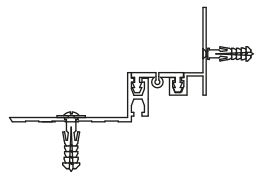

AR101-030 KÖŞE DETAYI  
AR101-030 CORNER DETAIL

### AR102-030

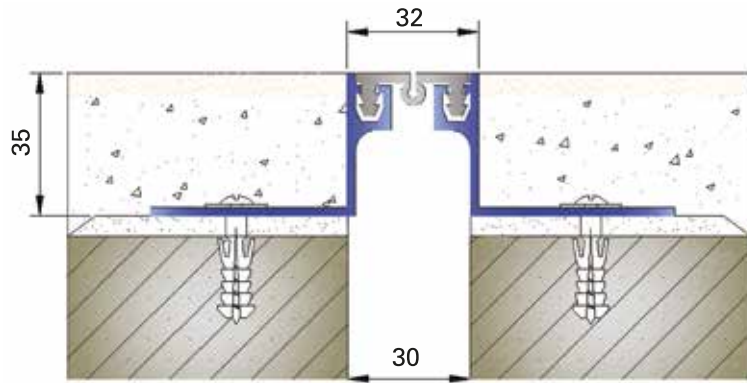

#### AÇIKLAMA / EXPLANATION

Endüstriyel zemin, granit, mermer gibi her türlü zemine uygun kaplama altı dilatasyon profili  
It is suitable for all kinds of floor such as industrial floor, granite, marble

#### TEKNİK ÖZELLİKLER / TECHNICAL FEATURES

Açıklık : 30 mm  
Width: 30 mm  
Yükseklik : 35 mm  
Height: 35 mm  
3,5 ton araç ve 2,5 ton forklift trafiğine dayanıklı  
Resistant to 3,5 ton of vehicle traffic and 2,5 ton forklift traffic  
Hareket Kapasitesi: ± 10mm  
Movement Capacity: ± 10mm  
Profil Boyu: 3mt.  
Profile Length: 3mt

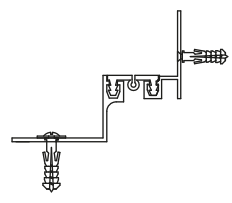

AR102-030 KÖŞE DETAYI  
AR102-030 CORNER DETAIL



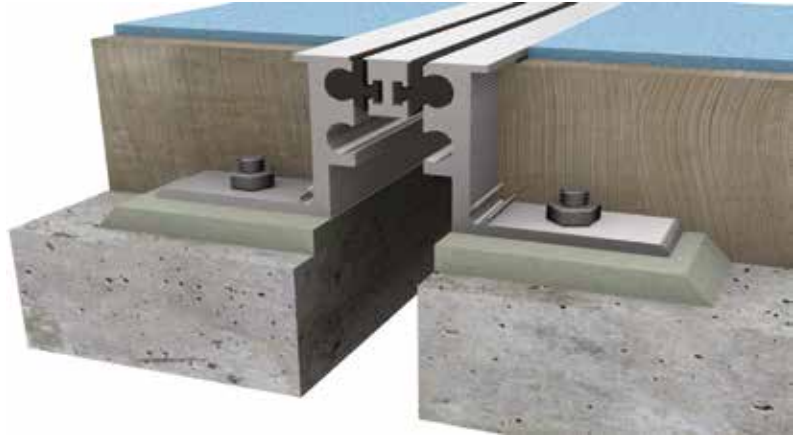

FİTİL RENKLERİ  
COLOURS OF INSERT

SIYAH	GRI	KREM
BLACK	GREY	CREAM

### AR103-030

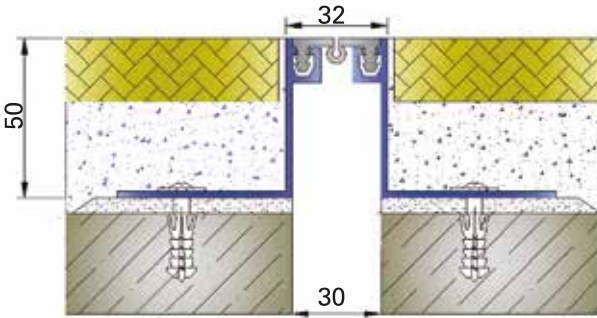

#### AÇIKLAMA / EXPLANATION

Endüstriyel zemin, mermer, şap... v.s. kaplamalara uygun dilatasyon profili.  
It is suitable for industrial floor, marble and granite.

#### TEKNİK ÖZELLİKLER / TECHNICAL FEATURES

Açıklık : 30 mm  
Width: 30 mm  
Yükseklik : 50 mm  
Height: 50 mm  
3,5 ton araç ve 2,5 ton forklift trafiğine dayanıklı  
Resistant to 3,5 tones vehicle and 2,5 tones forklift traffic.  
Hareket Kapasitesi: ± 10mm  
Movement Capacity: ± 10mm  
Profil Boyu: 3mt.  
Profile Length: 3mt

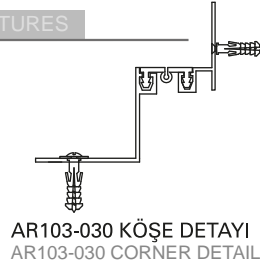

AR103-030 KÖŞE DETAYI  
AR103-030 CORNER DETAIL

### AR120-030

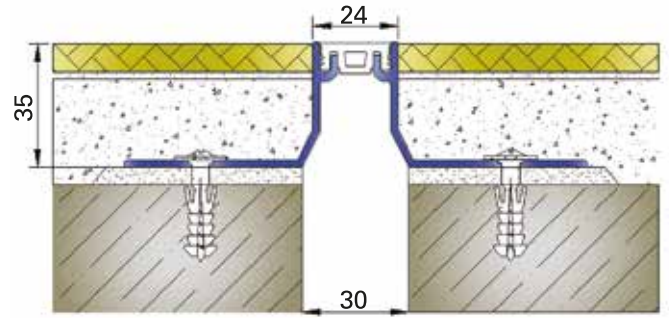

#### AÇIKLAMA / EXPLANATION

Dilatasyonda dar fitil istenen yerlerde kullanılan seramik, mermer, granit, halı v.s. kaplamalarla uyumlu dilatasyon profili.  
If the narrow insert is desired this profile is suitable for ceramic, marble and any other finishing material.

#### TEKNİK ÖZELLİKLER / TECHNICAL FEATURES

Açıklık : 30 mm  
Width: 30 mm  
Yükseklik : 35 mm  
Height: 35 mm  
Yaya trafiğine dayanıklı  
Resistant for pedestrian traffic.  
Hareket Kapasitesi: ± 3mm  
Movement Capacity: ± 3mm  
Profil Boyu: 3mt.  
Profile Length: 3mt

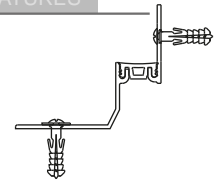

AR120-030 KÖŞE DETAYI  
AR120-030 CORNER DETAIL

### AR300-035

H:43  
H:14  
H:28  
H:60

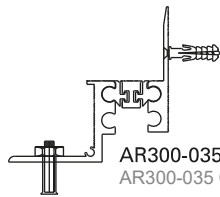

AR300-035 KÖŞE DETAYI  
AR300-035 CORNER DETAIL

#### AÇIKLAMA / EXPLANATION

Endüstriyel zemin, seramik, mermer vinil v.s. zeminlere uygun dilatasyon profili.  
Joint profile is suitable for overlays such as industrial floor, ceramic, marble and vinyl. Delivered in assembled.

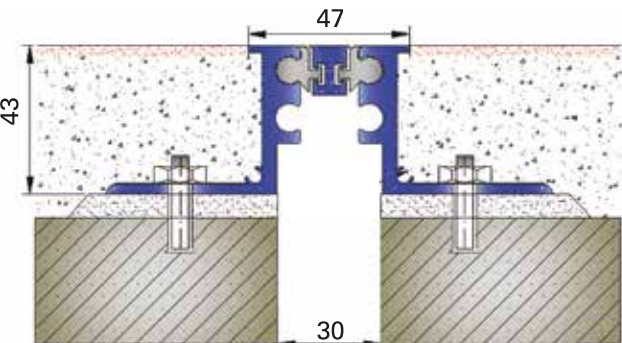

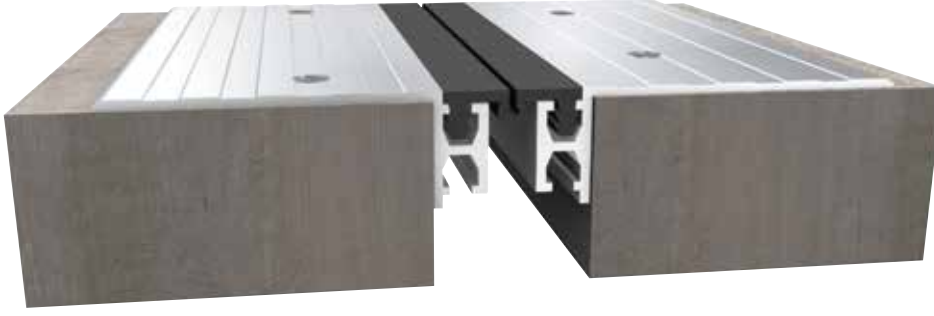

#### TEKNİK ÖZELLİKLER / TECHNICAL FEATURES

Açıklık : 30 mm  
Width: 30 mm  
Yükseklik : 14-28-43-60 mm  
Height: 14-28-43-60 mm  
Ağır yüklerde dayanıklı (30 ton araç 6,5 ton forklift)  
Resistant for heavy traffic (30 tones of vehicle - 6,5 tones of forklift)  
Hareket Kapasitesi: ± 5mm  
Movement Capacity: ± 5mm  
Profil Boyu: 3mt.  
Profile Length: 3mt



**FİTİL RENKLERİ**  
COLOURS OF INSERT

		
SİYAH	GİRİ	KREM
BLACK	GREY	CREAM

### AR150-030

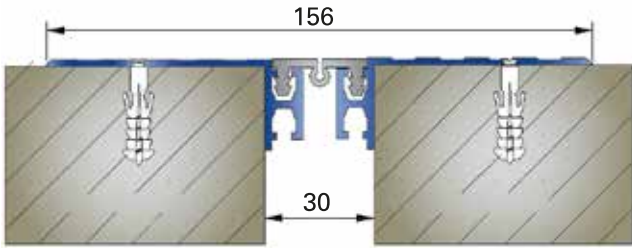

#### AÇIKLAMA / EXPLANATION

Kaplama üstü eloksalli zemin dilatasyon profili.  
Anodised dilatation profile for over finishing.

#### TEKNİK ÖZELLİKLER / TECHNICAL FEATURES

Açıklık : 30 mm  
Width: 30 mm  
Derinlik : 26 mm  
Depth: 26 mm  
5 ton araç, 2,5 ton forklift trafiğine dayanıklı  
Resistant to 5 tones vehicle and 2,5 tones forklift traffic.  
Hareket Kapasitesi: ± 10mm  
Movement Capacity: ± 10mm  
Profil Boyu: 3mt.  
Profile Length: 3mt

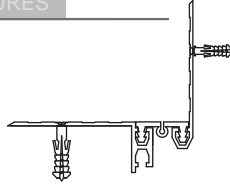

AR150-030 KÖŞE DETAYI  
AR150-030 CORNER DETAIL

### AR152-030

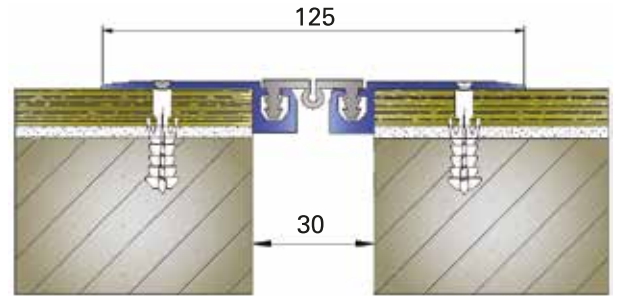

#### AÇIKLAMA / EXPLANATION

Kaplama üstü eloksalli zemin dilatasyon profili.  
Havşa başlı montaj delikleri açılmış olarak sevk edilir.  
Surface floor dilatation profile with anodised.  
It is submitted with the assembling holes open and ready.

#### TEKNİK ÖZELLİKLER / TECHNICAL FEATURES

Açıklık : 30 mm  
Width: 30 mm  
Derinlik : 15 mm  
Depth: 15 mm  
Yaya trafiğine dayanıklı.  
Resistant to pedestrian traffic.  
Hareket Kapasitesi: ± 10mm  
Movement Capacity: ± 10mm  
Profil Boyu: 3mt.  
Profile Length: 3mt

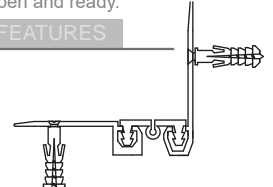

AR152-030 KÖŞE DETAYI  
AR152-030 CORNER DETAIL

### AR154-030

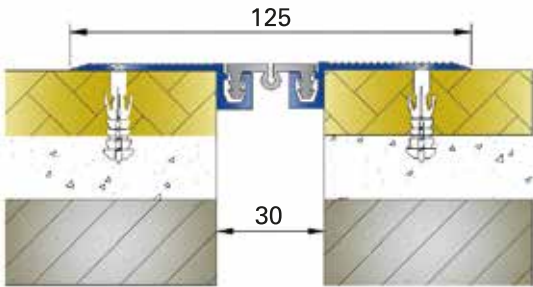

#### AÇIKLAMA / EXPLANATION

Kaplama üstü eloksalsiz zemin dilatasyon profili.  
Anodised joint profile for over finishing.

#### TEKNİK ÖZELLİKLER / TECHNICAL FEATURES

Açıklık : 30 mm  
Width: 30 mm  
Derinlik : 15 mm  
Depth: 15 mm  
Yaya trafiğine dayanıklı  
Resistant to pedestrian traffic  
Hareket Kapasitesi: ± 10mm  
Movement Capacity: ± 10mm  
Profil Boyu: 3mt.  
Profile Length: 3mt

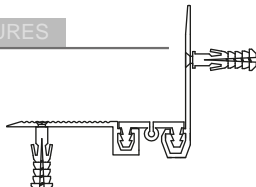

AR154-030 KÖŞE DETAYI  
AR154-030 CORNER DETAIL

### AR171-035

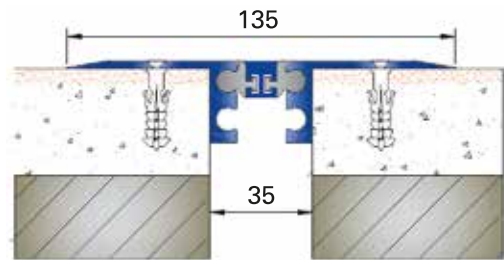

#### AÇIKLAMA / EXPLANATION

Kaplama üstü eloksalsiz zemin dilatasyon profili.  
Havşa başlı montaj delikleri açılmış olarak sevk edilir.  
Surface floor dilatation profile with anodised.  
It is submitted with the assembling holes open and ready.

#### TEKNİK ÖZELLİKLER / TECHNICAL FEATURES

Açıklık : 35 mm  
Width: 35 mm  
Derinlik : 26 mm  
Depth: 26 mm  
5 ton araç 2,5 ton forklift trafiğine dayanıklı  
Resistant to 5 tones vehicle and 2,5 tones forklift traffic.  
Hareket Kapasitesi: ± 5mm  
Movement Capacity: ± 5mm  
Profil Boyu: 3mt.  
Profile Length: 3mt

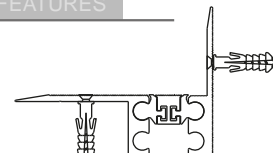

AR171-035 KÖŞE DETAYI  
AR171-035 CORNER DETAIL



FİTİL RENKLERİ  
COLOURS OF INSERT

SIYAH	GRI	KREM
BLACK	GREY	CREAM

## AR200-030

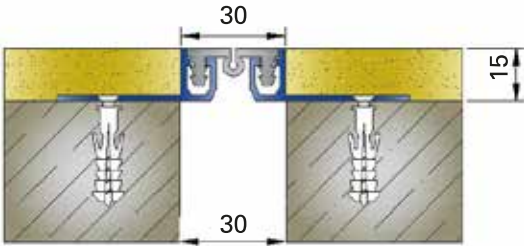

### AÇIKLAMA / EXPLANATION

Siva, seramik, alçıpan v.b. malzemelerle uygun kaplama altı dilatasyon profili.  
This wall and ceiling expansion joint profile is suitable for under plaster and drywall.

### TEKNİK ÖZELLİKLER / TECHNICAL FEATURES

Açıklık : 30 mm  
Width: 30 mm  
Yükseklik : 15 mm  
Height: 15 mm  
100,101,102,103 serisi zemin profilleri ile tam uyumlu  
Fully compatible with 100,101,102,103 series floor profiles  
Hareket Kapasitesi: ± 10mm  
Movement Capacity: ± 10mm  
Profil Boyu: 3mt.  
Profile Length: 3mt

(Bu profilin yüksekliği 20 mm ve 35 mm oları mevcuttur)  
(The height of this profile can also be 20 mm and 35 mm)

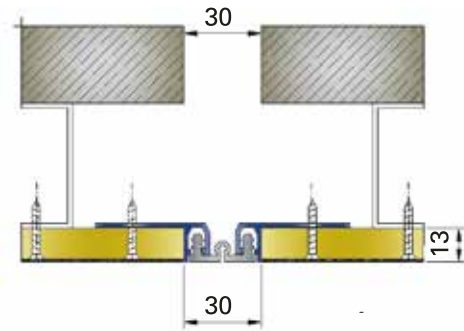

ALÇIPAN ASMA TAVAN ve BÖLME  
DUVAR DİLATASYON DETAYI  
DRYWALL CEILING PROFILE AND PARTITION  
WALL DILATATION DETAIL

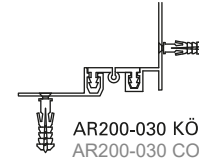

AR200-030 KÖŞE DETAYI  
AR200-030 CORNER DETAIL

## AR206-030

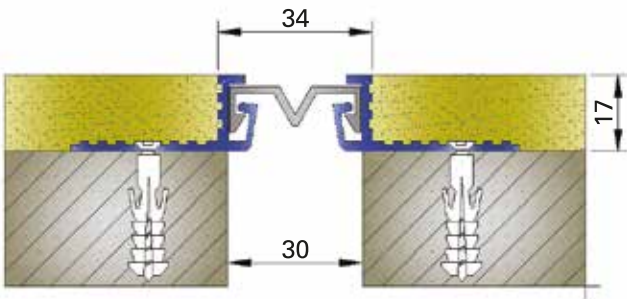

### AÇIKLAMA / EXPLANATION

Siva altı duvar tavan dilatasyon profili.  
Wall and ceiling dilatation profile for under plaster.

### TEKNİK ÖZELLİKLER / TECHNICAL FEATURES

Açıklık : 30 mm  
Width: 30 mm  
Yükseklik : 17 mm  
Height: 17 mm  
Hareket Kapasitesi: ± 10mm  
Movement Capacity: ± 10mm  
Profil Boyu: 3mt.  
Profile Length: 3mt

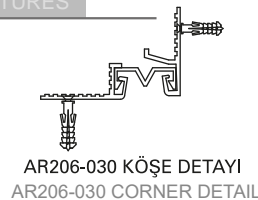

AR206-030 KÖŞE DETAYI  
AR206-030 CORNER DETAIL

## AR208-030

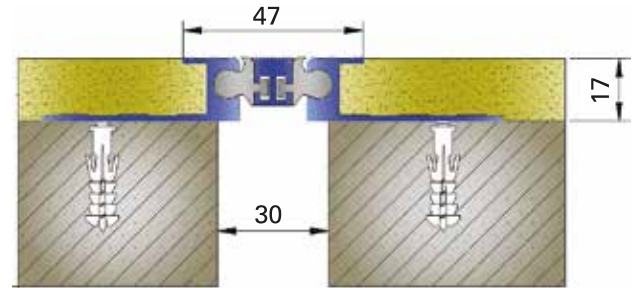

### AÇIKLAMA / EXPLANATION

Siva, seramik alçıpan v.b. malzemelere uygun kaplama altı dilatasyon profili.  
Overlay dilatation profile which is suitable for the materials such as plaster, ceramic and drywall.

### TEKNİK ÖZELLİKLER / TECHNICAL FEATURES

Açıklık : 30 mm  
Width: 30 mm  
Yükseklik : 17 mm  
Height: 17 mm  
AR300-035 ile tam uyumlu dekoratif  
A fully compatible with AR300 series profiles  
Hareket Kapasitesi: ± 5mm  
Movement Capacity: ± 5mm  
Profil Boyu: 3mt.  
Profile Length: 3mt

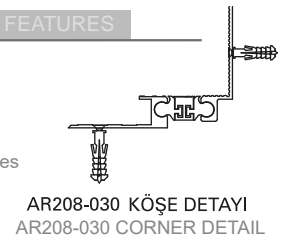

AR208-030 KÖŞE DETAYI  
AR208-030 CORNER DETAIL



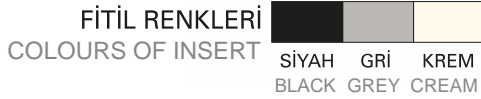
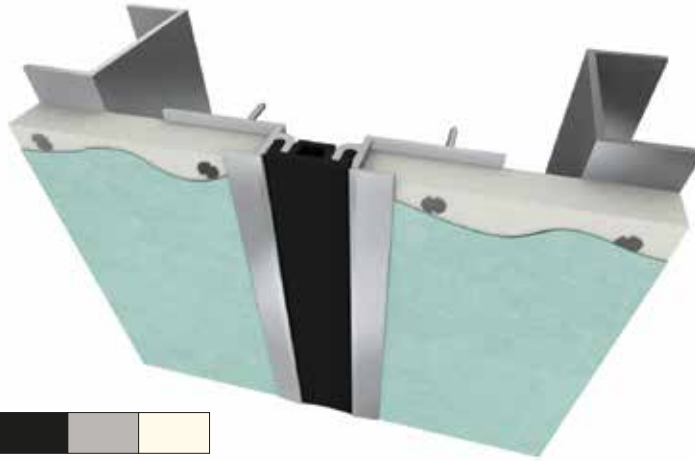

## AR220-031

### AÇIKLAMA / EXPLANATION

Alçıpan bölme duvar ve asma tavan uygulamaları için dar fitilli dilatasyon profili.  
 A dilatation profile with smooth insert which is used for the applications for drywall ceiling and partition wall ceiling.

### TEKNİK ÖZELLİKLER / TECHNICAL FEATURES

Açıklık : 20 - 30 mm  
 Width: 20 - 30 mm  
 Yükseklik : 12,5 mm  
 Height: 12,5 mm  
 AR120-030 Zemin Profili ile tam uyumlu  
 Fully compatible with AR120-030 floor profile  
 Hareket Kapasitesi: ± 3mm  
 Movement Capacity: ± 3mm  
 Profil Boyu: 3mt.  
 Profile Length: 3mt

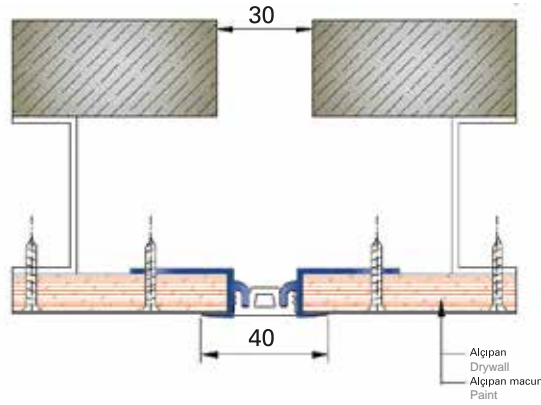

## AR220-030

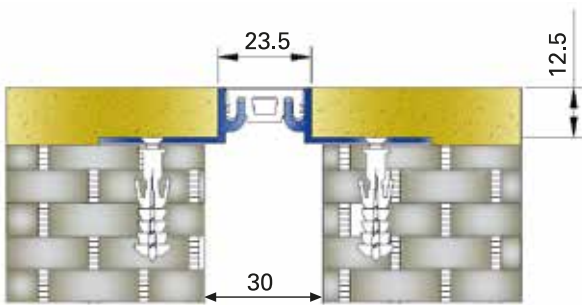

### AÇIKLAMA / EXPLANATION

Alçı sıva, yapıştırma seramik kaplamalar için uygun, fitilli dilatasyon profili.  
 A dilatation profile with insert which is suitable for gypsum plaster and ceramic overlays.

### TEKNİK ÖZELLİKLER / TECHNICAL FEATURES

Açıklık : 20-30 mm  
 Width: 20-30 mm  
 Yükseklik : 12,5 mm  
 Height: 12,5 mm  
 AR120-030 Zemin Profili ile tam uyumlu  
 Fully compatible with AR120-030 floor profile  
 Hareket Kapasitesi: ± 5mm  
 Movement Capacity: ± 5mm  
 Profil Boyu: 3mt.  
 Profile Length: 3mt

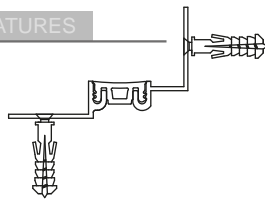

AR220-030 KÖŞE DETAYI  
 AR220-030 CORNER DETAIL

## AR221-030

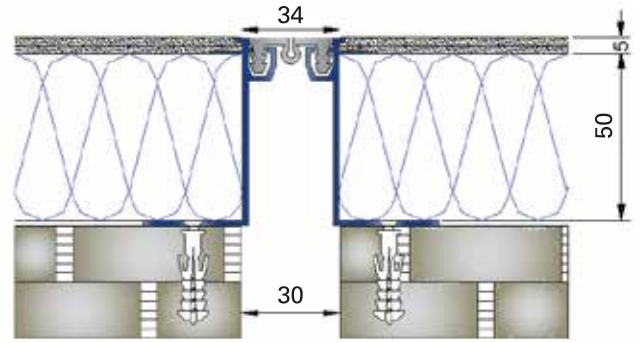

### AÇIKLAMA / EXPLANATION

Isı yalıtımlı dış cephelerde kullanılan dilatasyon profili.  
 A dilatation profile which is used for facade with heat insulation.

### TEKNİK ÖZELLİKLER / TECHNICAL FEATURES

Açıklık : 30 mm  
 Width: 30 mm  
 Yükseklik : 50+5 mm  
 Height: 50+5 mm  
 Hareket Kapasitesi: ± 10mm  
 Movement Capacity: ± 10mm  
 Profil Boyu: 3mt.  
 Profile Length: 3mt

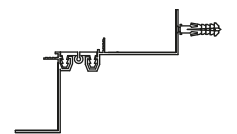

AR221-030 KÖŞE DETAYI  
 AR221-030 CORNER DETAIL

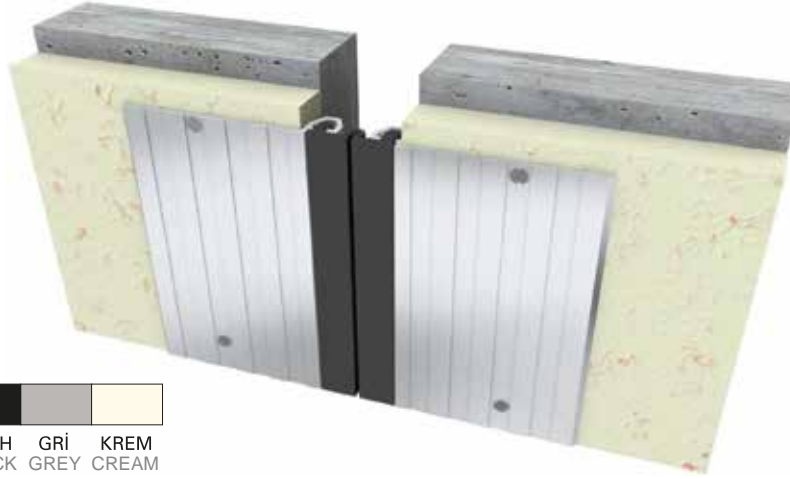

FİTİL RENKLERİ  
COLOURS OF INSERT

SIYAH	GRİ	KREM
BLACK	GREY	CREAM

## AR251-030

### AÇIKLAMA / EXPLANATION

Sıva üzeri eloksalli duvar tavan dilatasyon profili.  
Anodised wall and ceiling dilatation profile for over plaster or concrete.

### TEKNİK ÖZELLİKLER / TECHNICAL FEATURES

Açıklık : 30 mm  
Width: 30 mm  
Derinlik : 15 mm  
Depth: 15 mm  
AR150-030, AR100 serisi ile tam uyumlu  
Fully compatible with AR150-030, AR100 series  
Hareket Kapasitesi: ± 10mm  
Movement Capacity: ± 10mm  
Profil Boyu: 3mt.  
Profile Length: 3mt

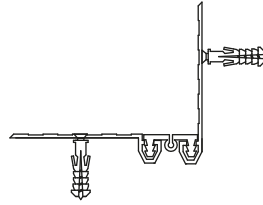
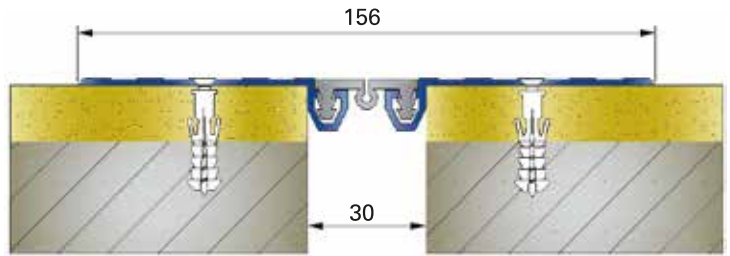

AR251-030 KÖŞE DETAYI  
AR251-030 CORNER DETAIL

## AR253-030

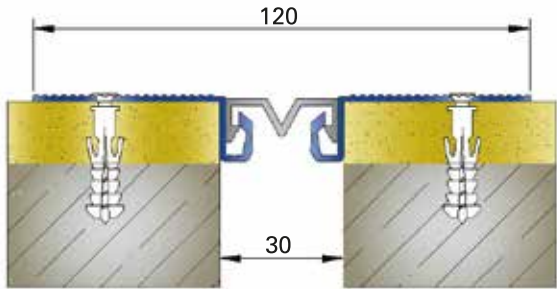

### AÇIKLAMA / EXPLANATION

Eloksalsız, sıva üstü duvar tavan dilatasyon profili.  
Wall and ceiling dilatasyon profile for over plaster.

### TEKNİK ÖZELLİKLER / TECHNICAL FEATURES

Açıklık : 20-30 mm  
Width: 20-30 mm  
Derinlik : 12,5 mm  
Depth: 12,5 mm  
Hareket Kapasitesi: ± 10mm  
Movement Capacity: ± 10mm  
Profil Boyu: 3mt.  
Profile Length: 3mt

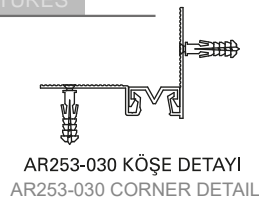

AR253-030 KÖŞE DETAYI  
AR253-030 CORNER DETAIL

## AR255-030

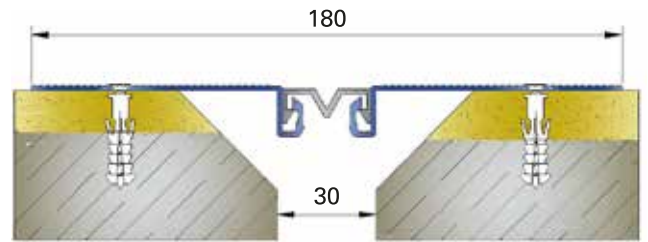

### AÇIKLAMA / EXPLANATION

Eloksalsız, sıva üstü duvar tavan dilatasyon profili.  
Wall and ceiling dilatation profile which is used for plaster or concrete wall.

### TEKNİK ÖZELLİKLER / TECHNICAL FEATURES

Açıklık : 20-30 mm  
Width: 20-30 mm  
Derinlik : 12,5 mm  
Depth: 12,5 mm  
Hareket Kapasitesi: ± 10mm  
Movement Capacity: ± 10mm  
Profil Boyu: 3mt.  
Profile Length: 3mt

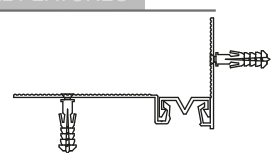

AR255-030 KÖŞE DETAYI  
AR255-030 CORNER DETAIL



**FİTİL RENKLERİ**  
COLOURS OF INSERT

SIYAH	GRI	KREM
BLACK	GREY	CREAM

### AR258-030

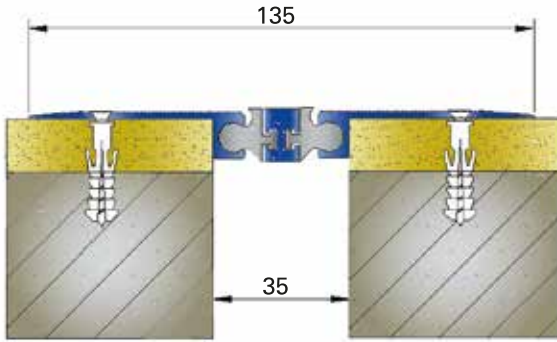

#### AÇIKLAMA / EXPLANATION

Vida delikli, sıva üstü duvar tavan dilatasyon profili.  
Profil montajlı olarak sevk edilir.  
Wall and ceiling dilatation profile for over plaster.  
It is delivered with in an assembled state.

#### TEKNİK ÖZELLİKLER / TECHNICAL FEATURES

Açıklık : 35 mm  
Width: 35 mm  
Derinlik : 15 mm  
Depth: 15 mm  
AR171-035 ve AR300-035 ile tam uyumlu  
Wall and ceiling dilatation profile which is fully compatible with AR171-035 and AR300-035  
Hareket Kapasitesi: ± 5mm  
Movement Capacity: ± 5mm  
Profil Boyu: 3mt.  
Profile Length: 3mt

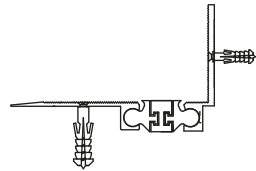

AR258-030 KÖŞE DETAYI  
AR258-030 CORNER DETAIL

### AR260-030

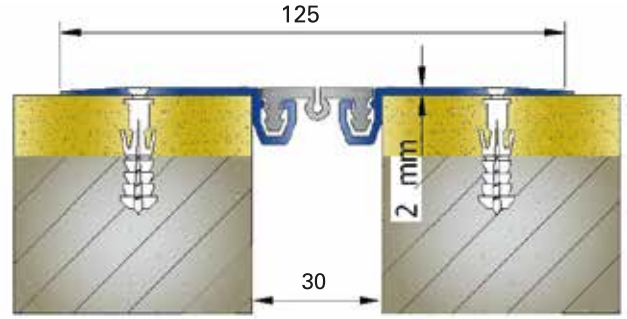

#### AÇIKLAMA / EXPLANATION

Vida delikli, eloksalı, sıva üstü duvar tavan dilatasyon profili.  
Wall and ceiling dilatation profile which is on plaster with holes for screw.

#### TEKNİK ÖZELLİKLER / TECHNICAL FEATURES

Açıklık : 30 mm  
Width: 30 mm  
Derinlik : 15 mm  
Depth: 15 mm  
AR152-030, AR100 serisi ile tam uyumlu  
Fully compatible with AR152-030 and AR100 series  
Profil et kalınlığı: 2 mm  
Profile thickness: 2mm  
Hareket Kapasitesi: ± 10mm  
Movement Capacity: ± 10mm  
Profil Boyu: 3mt.  
Profile Length: 3mt

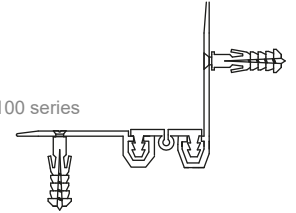

AR260-030 KÖŞE DETAYI  
AR260-030 CORNER DETAIL

### AR262-030

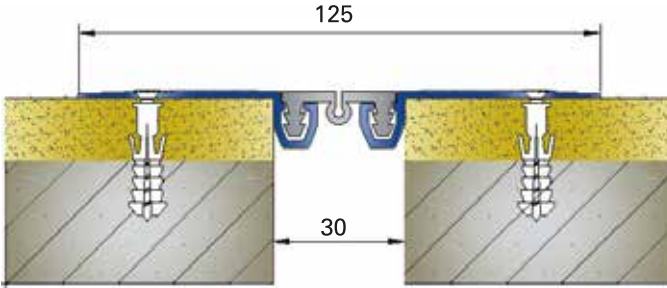

#### AÇIKLAMA / EXPLANATION

Vida delikli, eloksalı, sıva üstü duvar tavan dilatasyon profili.  
Wall and ceiling dilatation profile which is over finishing.  
With its holes for screw and anodised surface.

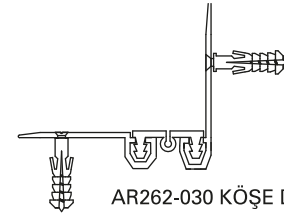

AR262-030 KÖŞE DETAYI  
AR262-030 CORNER DETAIL

#### TEKNİK ÖZELLİKLER / TECHNICAL FEATURES

Açıklık : 30 mm  
Width: 30 mm  
Derinlik : 15 mm  
Depth: 15 mm  
AR152-030 ve AR100 serisi ile tam uyumlu  
Fully compatible with AR152-030 and AR100 series  
Profil et kalınlığı: 1,5 mm  
Profile thickness: 1,5 mm  
Hareket Kapasitesi: ± 10mm  
Movement Capacity: ± 10mm  
Profil Boyu: 3mt.  
Profile Length: 3mt



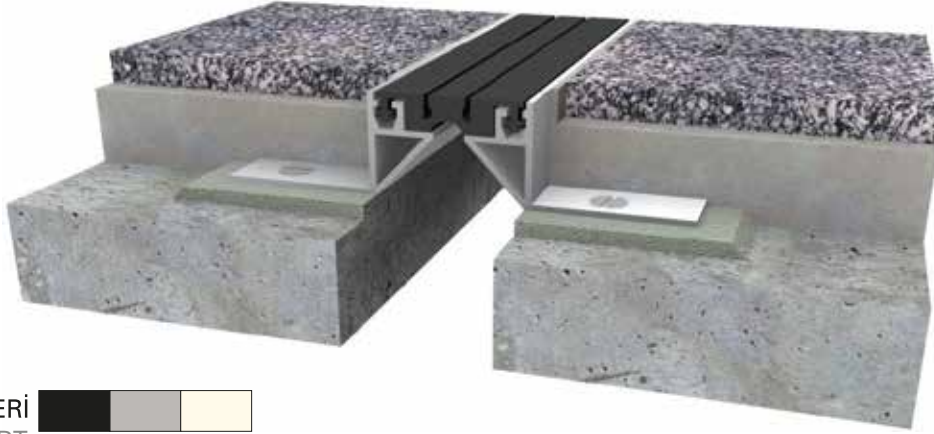

FİTİL RENKLERİ  
COLOURS OF INSERT

SIYAH	GRI	KREM
BLACK	GREY	CREAM

### AR105-050

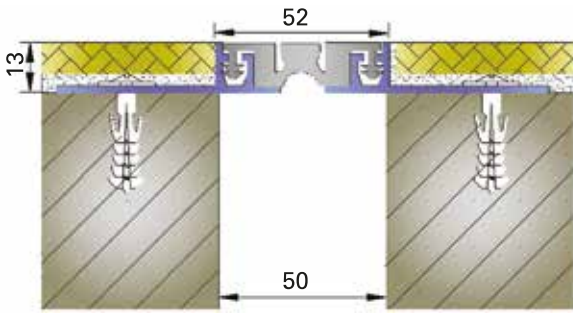

#### AÇIKLAMA / EXPLANATION

Seramik, granit seramik v.s. kaplamalarla uyumlu dilatasyon profili.  
Joint profile compatible with ceramic, granite ceramic etc.

#### TEKNİK ÖZELLİKLER / TECHNICAL FEATURES

Açıklık : 50 mm  
Width: 50 mm  
Yükseklik : 13 mm  
Height: 13 mm  
Yaya trafiğine dayanıklı  
Resistant to the pedestrian traffic  
Hareket Kapasitesi: ± 10mm  
Movement Capacity: ± 10mm  
Profil Boyu: 3mt.  
Profile Length: 3mt

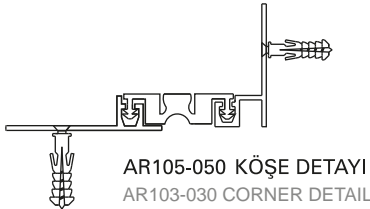

AR105-050 KÖŞE DETAYI  
AR103-030 CORNER DETAIL

### AR106-050

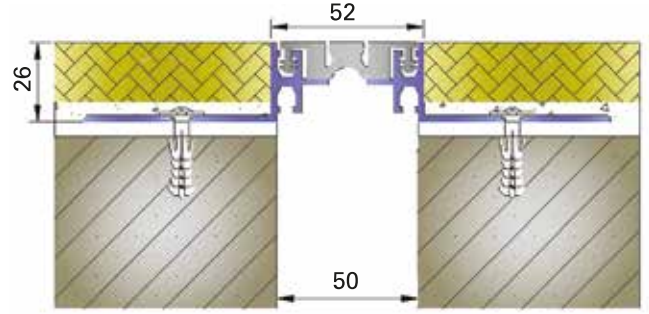

#### AÇIKLAMA / EXPLANATION

Doğal granit, mermer karo mozaik v.s. kaplamalara uygun dilatasyon profili.  
Joint profile compatible with natural granite, marble mosaic etc.

#### TEKNİK ÖZELLİKLER / TECHNICAL FEATURES

Açıklık : 50 mm  
Width: 50 mm  
Yükseklik : 26 mm  
Height: 26 mm  
2,5 ton araç trafiğine dayanıklı  
Resistant to 2,5 tones vehicle traffic  
Hareket Kapasitesi: ± 10mm  
Movement Capacity: ± 10mm  
Profil Boyu: 3mt.  
Profile Length: 3mt

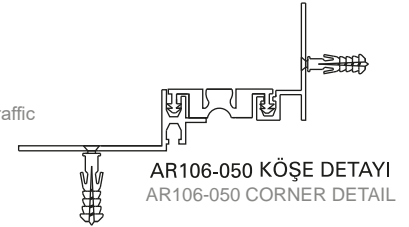

AR106-050 KÖŞE DETAYI  
AR106-050 CORNER DETAIL

### AR107-050

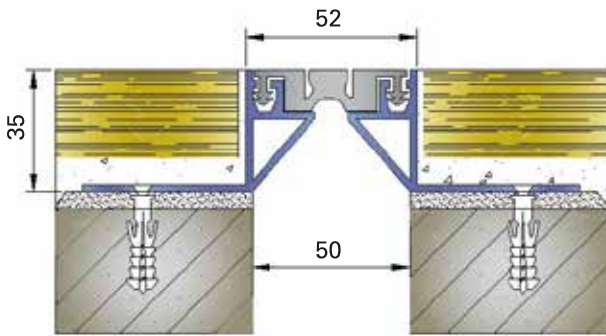

#### AÇIKLAMA / EXPLANATION

Granit, endüstriyel zemin, şap gibi zemin kaplamalarına uygun dilatasyon profili.  
Joint profile compatible with granite, industrial floor, flap etc. cover

#### TEKNİK ÖZELLİKLER / TECHNICAL FEATURES

Açıklık : 50 mm  
Width: 50 mm  
Yükseklik : 35 mm  
Height: 35 mm  
2,5 ton araç ve 2 ton forklift trafiğine dayanıklı  
Resistant to the 2,5 tones vehicle traffic and 2 tones forklift traffic  
Hareket Kapasitesi: ± 10mm  
Movement Capacity: ± 10mm  
Profil Boyu: 3mt.  
Profile Length: 3mt

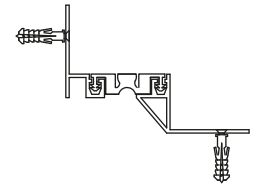

AR107-050 KÖŞE DETAYI  
AR107-050 CORNER DETAIL

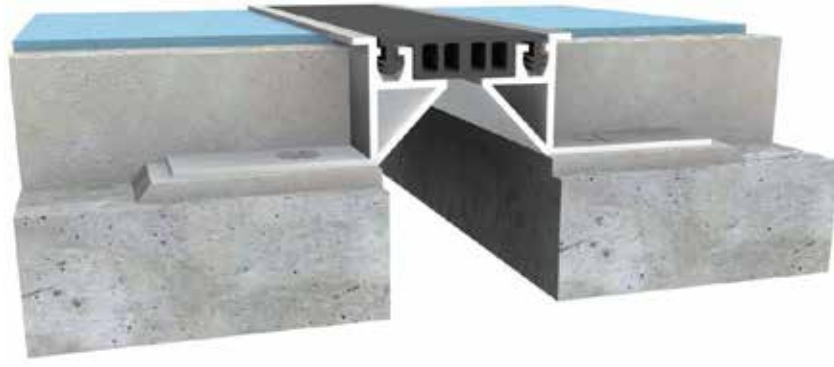

**FİTİL RENKLERİ**  
COLOURS OF INSERT

SIYAH	GRI	KREM
BLACK	GREY	CREAM

**AR107-052**

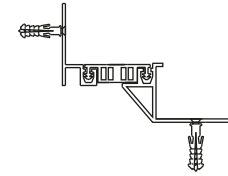
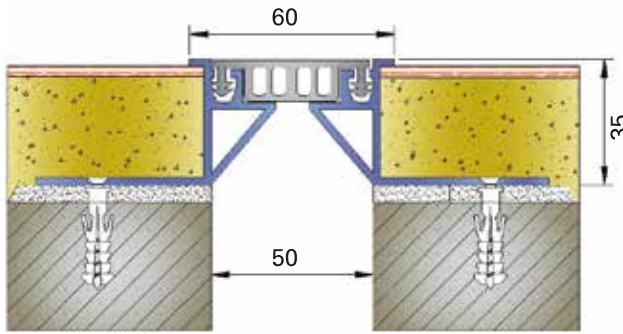

AR107-052 KÖŞE DETAYI  
AR107-052 CORNER DETAIL

**AÇIKLAMA / EXPLANATION**

PVC zemin kaplamaları, seramik, granit v.s. kaplamalara uygun dilatasyon profili.  
Joint profile compatible with PVC floor covers, ceramics, granite etc.

**TEKNİK ÖZELLİKLER / TECHNICAL FEATURES**

Açıklık : 50 mm  
Width: 50 mm  
Yükseklik : 35 mm  
Height: 35 mm  
2,5 ton araç ve 2 ton forklift trafiğine dayanıklı  
Resistant to the 2,5 tones vehicle and 2 tones forklift traffic  
Hareket Kapasitesi: ± 6mm  
Movement Capacity: ± 6mm  
Profil Boyu: 3mt.  
Profile Length: 3mt

**AR107-053**

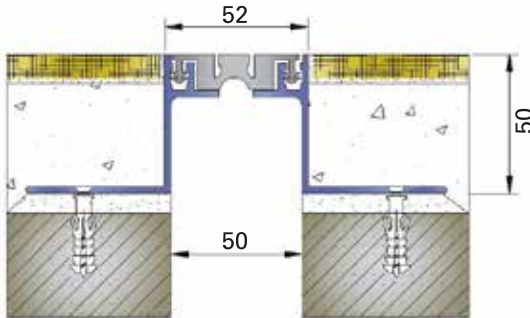

**AÇIKLAMA / EXPLANATION**

Kaplama yüksekliğinin en az 5cm olması koşuluyla her türlü zemin kaplamasına uygun dilatasyon profili.  
Joint profile compatible with every floor covering provided its cover height is 5 cm or more.

**TEKNİK ÖZELLİKLER / TECHNICAL FEATURES**

Açıklık : 50 mm  
Width: 50 mm  
Yükseklik : 50 mm  
Height: 50 mm  
2,5 ton araç trafiğine dayanıklı(yoğun olmayan)  
Resistant to occasionally car traffic  
Hareket Kapasitesi: ± 10mm  
Movement Capacity: ± 10mm  
Profil Boyu: 3mt.  
Profile Length: 3mt

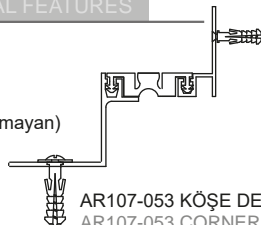

AR107-053 KÖŞE DETAYI  
AR107-053 CORNER DETAIL

**AR107-054**

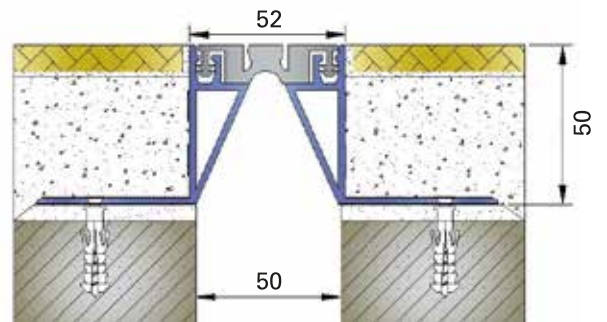

**AÇIKLAMA / EXPLANATION**

Kaplama yüksekliğinin en az 5cm olması koşuluyla her türlü zemin kaplamasına uygun dilatasyon profili.  
Joint profile compatible with every floor covering provided its cover height is 5cm or more.

**TEKNİK ÖZELLİKLER / TECHNICAL FEATURES**

Açıklık : 50 mm  
Width: 50 mm  
Yükseklik : 50 mm  
Height: 50 mm  
2,5 ton araç ve 2 ton forklift trafiğine dayanıklı  
Resistant to the 2,5 tones vehicle traffic and 2 tones forklift traffic  
Hareket Kapasitesi: ± 10mm  
Movement Capacity: ± 10mm  
Profil Boyu: 3mt.  
Profile Length: 3mt

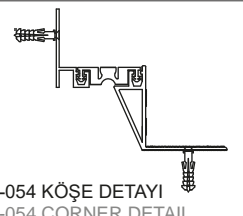

AR107-054 KÖŞE DETAYI  
AR107-054 CORNER DETAIL



## AR301-050

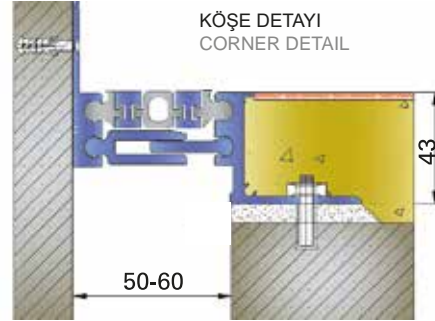
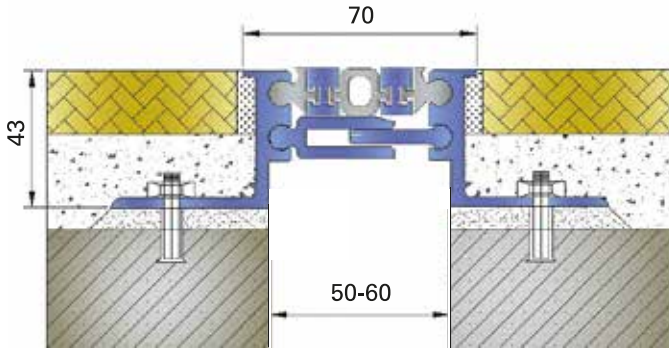

Farklı ayak yükseklikleri ile her türlü zeminde kullanılabilme imkanı  
It can be used on all kinds of floors with different height legs.

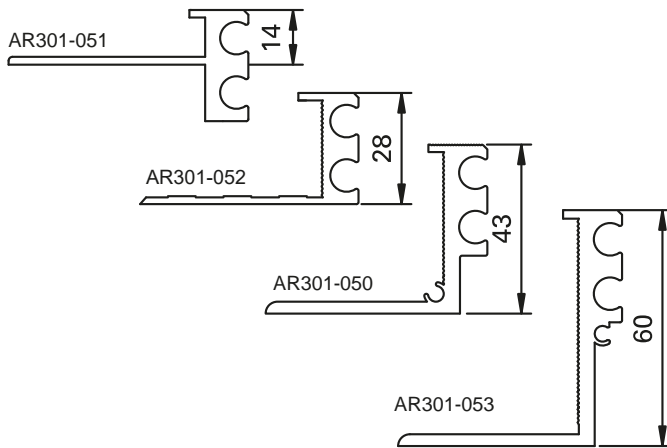

## AR308-050

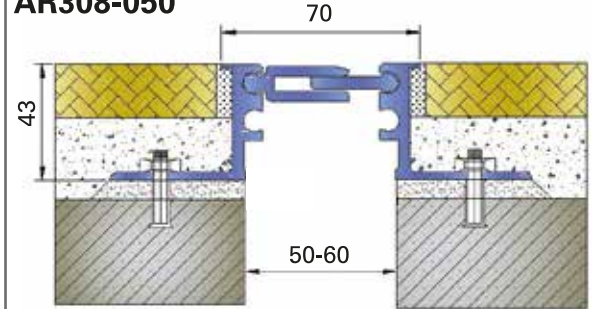

### TEKNİK ÖZELLİKLER / TECHNICAL FEATURES

Açıklık : 50-100 mm aralığında

Width : between 50-100 mm

Yükseklik : 14-28-43-60 mm

Height : 14-28-43-60 mm

9 ton araç yükü, 5 ton forklift yüküne dayanıklı.

Bu yük dayanımı dilatasyon açıklığı 50mm için geçerlidir.

Resistant to the 9 tones vehicle load and 5 tones forklift load.

These loads durations are only for 50mm joint width.

Profil Boyu: 3mt.

Profile Length: 3mt

### AÇIKLAMA / EXPLANATION

Endüstriyel yapılar, hastaneler, otoparklar ve benzeri bir çok yapıda kullanılan dekoratif, montajı kolay ve aynı zamanda ağır yüklere dayanıklı dilatasyon profili. Düz üst yüzey ve dekoratif görünüş dolayısıyla granit, mermer ve PVC zemin kaplamaları ile kullanımı da oldukça yaygındır. Profil montajlı olarak sevk edilir.

Joint profile which is used in industrial structures, carparks, hospitals and all kinds of structures is decorative, easy to assemble and resistant to the heavy loads.

### TEKNİK ÖZELLİKLER / TECHNICAL FEATURES

Açıklık : 50-200 mm aralığında / Width : between 50-200 mm

Yükseklik : 14-28-43-60 mm / Height : 14-28-43-60 mm

15 ton araç yükü, 6 ton forklift yüküne dayanıklı. Bu yük dayanımı dilatasyon açıklığı 50mm için geçerlidir.

Resistant to the 15 tones vehicle load and 6 tones forklift load. These loads can be used for only 50mm joint width.

Profil Boyu: 3mt.

Profile Length: 3mt





## AR703-050

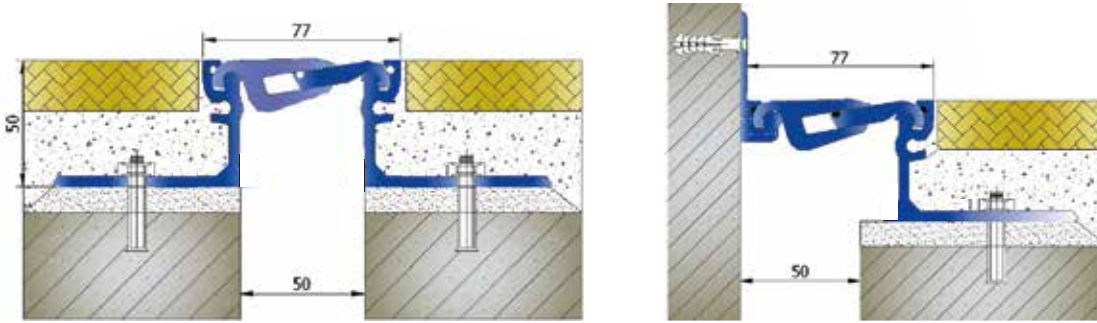

Farklı ayak yükseklikleri ile her türlü zeminde kullanılabilme imkanı.  
It can be used on all kinds of floors with different leg alternatives.

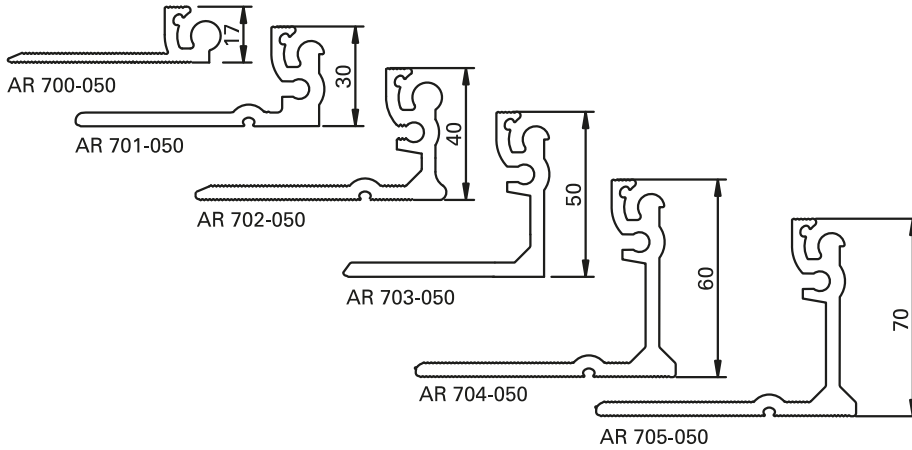

## AÇIKLAMA / EXPLANATION

Endüstriyel yapılarda forklift trafiğine dayanıklı olduğu için hastane ve alveriş merkezi gibi yapılarda ise düz üst yüzeyi dolayısıyla hijyenik olması ve Epdm contaları dolayısıyla da sesi izole ettiği için tercih edilir. AR700 serisi profiller montajlı bir şekilde sevk edilir.

AR700 series of profiles are delivered in an assembled state. Resistant to the forklift traffic in industrial structures, its even upper surface makes it very hygienic and its epdm joint allows it to isolate sounds.

## TEKNİK ÖZELLİKLER / TECHNICAL FEATURES

Açıklık : 50-100 mm aralığında

Width: between 50-100 mm

Yükseklik : 17-30-40-50-60-70 mm

Height: 17-30-40-50-60-70 mm

30 ton araç yükü 6,5 ton forklift aks yüküne dayanıklı. Bu yük dayanımı dilatasyon açıklığı 50mm için geçerlidir.

Resistant to the 30 tones vehicle load and 6,5 tones forklift axle load. These load durations are only for 50mm joint width.

Profil Boyu: 4mt.

Profile Length: 4mt



FİTİL RENKLERİ  
COLOURS OF INSERT

SIYAH	GİRİ	KREM
BLACK	GREY	CREAM

### AR151-050

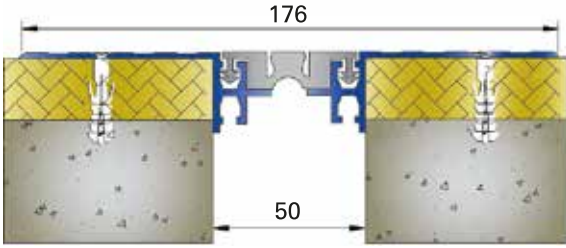

#### AÇIKLAMA / EXPLANATION

Kaplama üstü, eloksalli zemin dilatasyon profili.  
Joint profile compatible with ceramic, granite ceramic etc.

#### TEKNİK ÖZELLİKLER / TECHNICAL FEATURES

Açıklık : 50 mm  
Width: 50 mm  
Derinlik : 26 mm  
Depth: 26 mm  
3 ton araç trafiğine dayanıklı  
Resistant to 3 tones vehicle traffic  
Hareket Kapasitesi: ± 10mm  
Movement Capacity: ± 10mm  
Profil Boyu: 3mt.  
Profile Length: 3mt

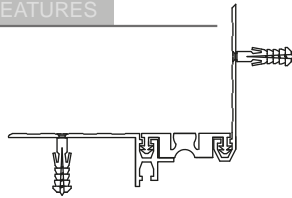

AR151-050 KÖŞE DETAYI  
AR151-050 CORNER DETAIL

### AR151-051

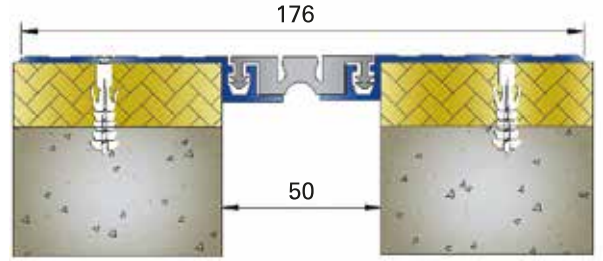

#### AÇIKLAMA / EXPLANATION

Kaplama üstü, eloksalli zemin dilatasyon profili.  
Joint profile compatible with ceramic, granite ceramic etc.

#### TEKNİK ÖZELLİKLER / TECHNICAL FEATURES

Açıklık : 50 mm  
Width: 50 mm  
Derinlik : 15 mm  
Depth: 15 mm  
Yaya trafiğine dayanıklı  
Resistant to the pedestrian traffic  
Hareket Kapasitesi: ± 10mm  
Movement Capacity: ± 10mm  
Profil Boyu: 3mt.  
Profile Length: 3mt

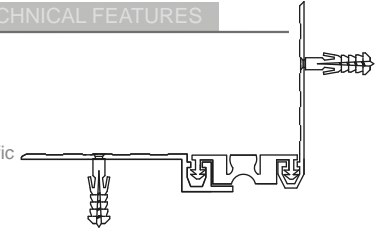

AR151-051 KÖŞE DETAYI  
AR151-051 CORNER DETAIL

### AR153-050

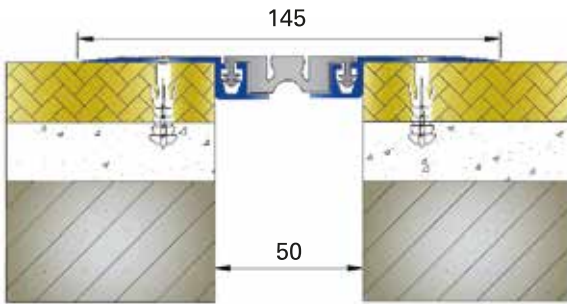

#### AÇIKLAMA / EXPLANATION

Kaplama üstü, eloksalli montaj delikleri açılmış  
zemin dilatasyon profili.  
Anodised jonit profiles for over finishing.  
(with screw holes)

#### TEKNİK ÖZELLİKLER / TECHNICAL FEATURES

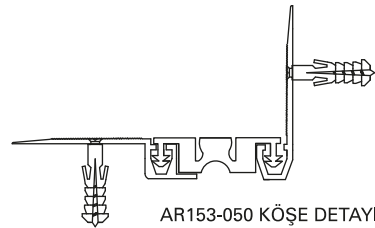

Açıklık : 50 mm  
Width: 50 mm  
Derinlik : 15 mm  
Depth: 15 mm  
Yaya trafiğine dayanıklı  
Resistant to the pedestrian traffic  
Hareket Kapasitesi: ± 10mm  
Movement Capacity: ± 10mm  
Profil Boyu: 3mt.  
Profile Length: 3mt



AR153-050 KÖŞE DETAYI  
AR153-050 CORNER DETAIL



**FİTİL RENKLERİ**  
COLOURS OF INSERT

		
SİYAH	GİRİ	KREM
BLACK	GREY	CREAM

### AR154-050

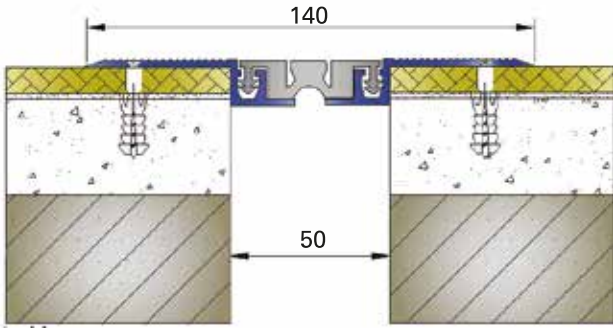

#### AÇIKLAMA / EXPLANATION

Kaplama üstü eloksalsiz zemin dilatasyon profili.  
Joint profiles for finishing. (without anodised)

#### TEKNİK ÖZELLİKLER / TECHNICAL FEATURES

Açıklık : 50 mm  
Width: 50 mm  
Derinlik : 15 mm  
Depth: 15 mm  
Yaya trafiğine dayanıklı  
Resistant to the pedestrian traffic  
Hareket Kapasitesi: ± 10mm  
Movement Capacity: ± 10mm  
Profil Boyu: 3mt.  
Profile Length: 3mt

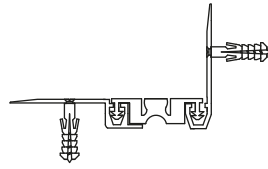

AR154-050 KÖŞE DETAYI  
AR154-050 CORNER DETAIL

### AR172-050

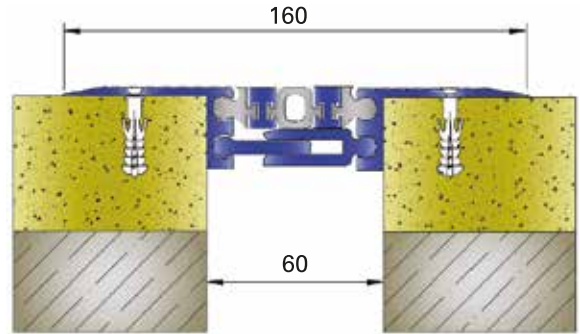

#### AÇIKLAMA / EXPLANATION

Granit, seramik, vinil, endüstriyel zemin vb. kaplamalara uygun montaj delikleri açılmış zemin dilatasyon profili.  
Joint profile is suitable for granite, ceramic, vinyl, industrial floor v.s. coverings. (with screw holes)

#### TEKNİK ÖZELLİKLER / TECHNICAL FEATURES

Açıklık : 60 mm  
Width: 60 mm  
Derinlik : 26 mm  
Depth: 26 mm  
3,5 ton araç, 2 ton forklift trafiğine dayanıklı.  
Resistant to 3,5 tones vehicle traffic and 2 tones forklift traffic  
Hareket Kapasitesi: ± 10mm  
Movement Capacity: ± 10mm

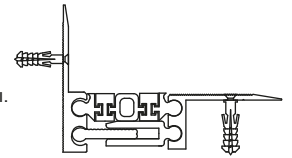

AR172-050 KÖŞE DETAYI  
AR172-050 CORNER DETAIL

### AR753-050

#### AÇIKLAMA / EXPLANATION

Özellikle endüstriyel zeminlerde kullanılan ağır yüklerle dayanıklı kaplama üstü zemin dilatasyon profili.  
Her iki tarafta montaj delikleri açılmıştır.  
Joint profile resistant to heavy loads. It is used for industrial floors. It has screw holes on both sides.

#### TEKNİK ÖZELLİKLER / TECHNICAL FEATURES

Açıklık : 50 mm  
Width: 50 mm  
Derinlik : 17 mm  
Depth: 17 mm  
6 ton araç yükü, 3,5 ton forklift yüküne dayanıklı  
Resistant to 6 tones vehicle traffic and 3,5 tones forklift traffic  
Hareket Kapasitesi: ± 10mm  
Movement Capacity: ± 10mm  
Profil Boyu: 4mt.  
Profile Length: 4mt

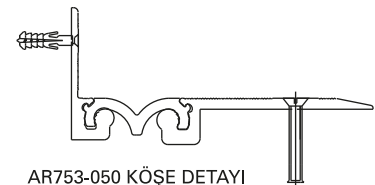
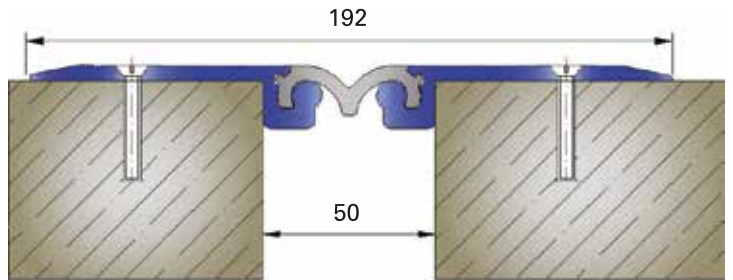

AR753-050 KÖŞE DETAYI  
AR73-050 CORNER DETAIL





## AR911-050

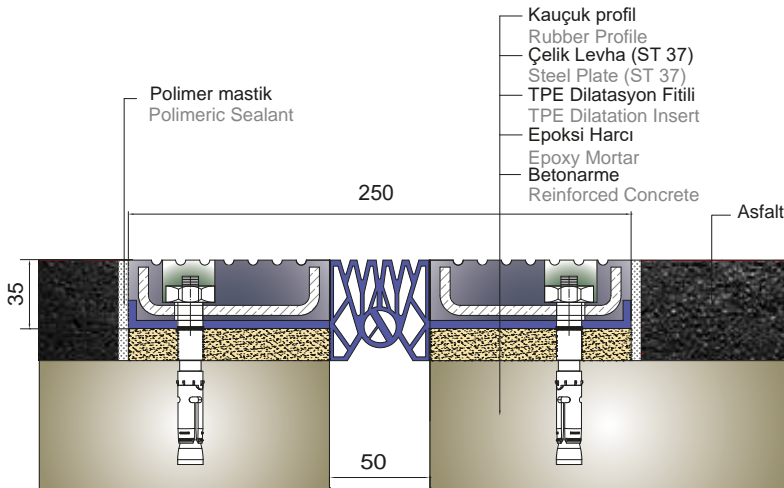

### AÇIKLAMA / EXPLANATION

Köprü dilatasyonları, bina yaklaşım köprüleri, otopark dilatasyonlarında kullanılan, ST37 çelik ve kauçuktan mamul kompozit dilatasyon profili. This composite profile is used for especially carparks, and bridges which is located on roadways or shopping malls (It is not suitable for highway roads)

### TEKNİK ÖZELLİKLER / TECHNICAL FEATURES

Açıklık : 50 mm  
Width: 50 mm  
Yükseklik : 35 mm  
Height: 35 mm  
AASHTO HS20'ye göre 14,5 ton araç aks yüküne dayanıklı.  
Resistant to 14,5 tones vehicle axle traffic according to AASHTO.  
Hareket Kapasitesi: ± 25mm  
Movement Capacity: ± 25mm  
Profil Boyu: 2mt.  
Profile Length: 2mt  
Fitolu Boyu: 16mt.  
Fitolu Length: 16mt

## AR911-051

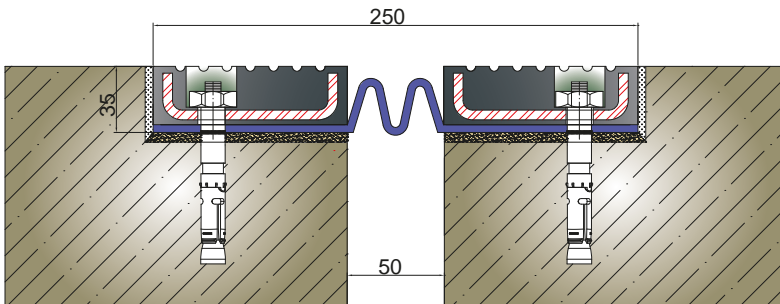

### AÇIKLAMA / EXPLANATION

Köprü dilatasyonları, bina yaklaşım köprüleri, otopark dilatasyonlarında kullanılan, ST37 çelik ve kauçuktan mamul kompozit dilatasyon profili. This composite profile is used for especially carparks, and bridges which is located on roadways or shopping malls (It is not suitable for highway roads)

### TEKNİK ÖZELLİKLER / TECHNICAL FEATURES

Açıklık : 50 mm  
Width: 50 mm  
Yükseklik : 35 mm  
Height: 35 mm  
AASHTO HS20'ye göre 14,5 ton araç aks yüküne dayanıklı.  
Resistant to 14,5 tones vehicle axle traffic according to AASHTO.  
Hareket Kapasitesi: ± 40mm  
Movement Capacity: ± 40mm  
Profil Boyu: 2mt.  
Profile Length: 2mt  
Fitolu Boyu: 16mt.  
Fitolu Length: 16mt

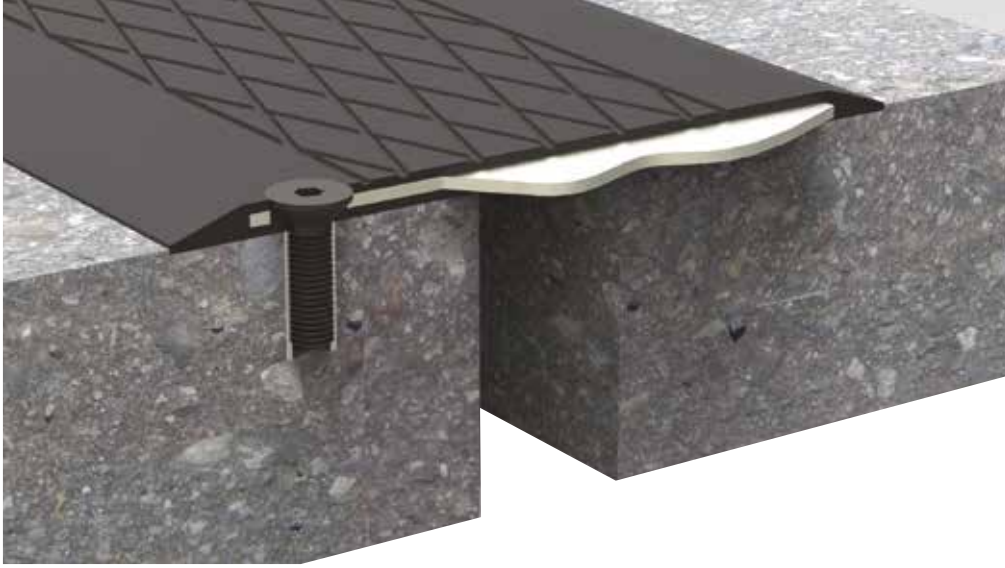

**AR951-050**

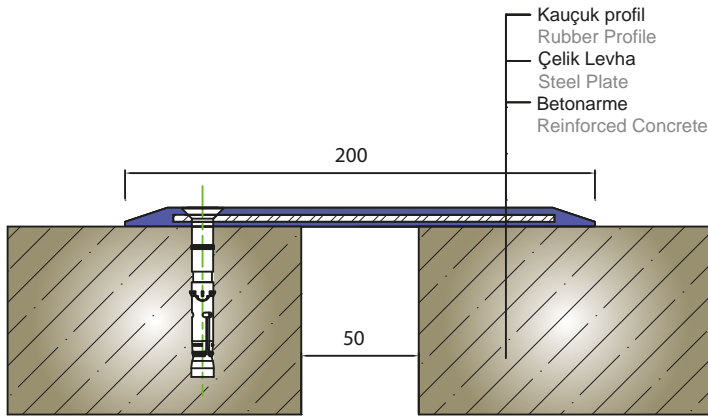

**AÇIKLAMA / EXPLANATION**

Otopark dilatasyonlarında kullanılan, ST37 çelik ve kauçuktan mamul, zemin dilatasyon profili.  
This special composite profile is made of from high quality rubber and steel sheet. Especially it is suitable for carpark area where there isn't any finishing material. It is also best solution for repairing on exist carparks.

**TEKNİK ÖZELLİKLER / TECHNICAL FEATURES**

Açıklık : 50 mm  
Width: 50 mm  
Yükseklik : 8 mm  
Height: 35 mm  
16 ton araç, 3.5 ton forklift yüküne dayanıklı.  
Resistant to 16 tones vehicle traffic and 3.5 tones forklift traffic.  
Profil Boyu: 2mt.  
Profile Length: 2mt

**AR921-051**

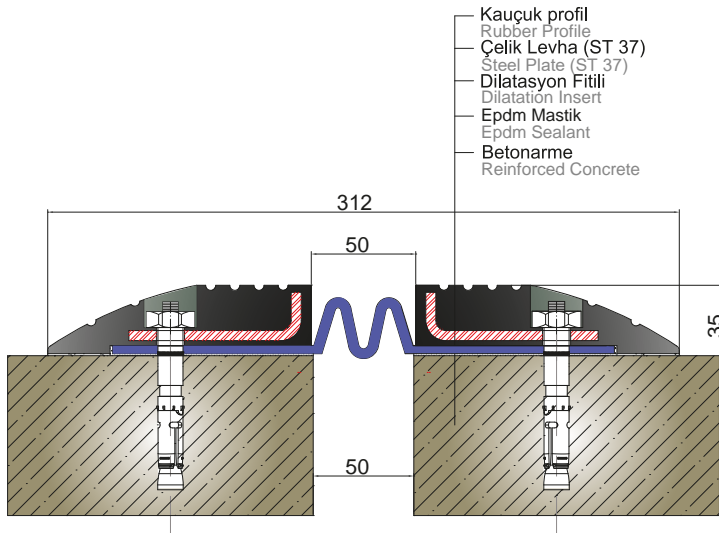

**AÇIKLAMA / EXPLANATION**

Otopark dilatasyonlarında kullanılan, ST37 çelik ve kauçuktan mamul, kasis özelliği, rampa tipi kompozit dilatasyon profili.  
This special composite profile is made of from high quality rubber and steel sheet. Especially it is suitable for carpark area where there isn't any finishing material. It is also best solution for repairing on exist carparks.

**TEKNİK ÖZELLİKLER / TECHNICAL FEATURES**

Açıklık : 50 mm  
Width: 50 mm  
Yükseklik : 35 mm  
Height: 35 mm  
6,5 ton araç aks yüküne dayanıklı. Kaymaya karşı yüzeyi çizgili.  
Resistant to 6,5 axle load. It has also line over the profile for anti slip.  
Hareket Kapasitesi: ± 40mm  
Movement Capacity: ± 40mm  
Profil Boyu: 2mt.  
Profile Length: 2mt  
Fıtıl Boyu: 16mt.  
Fıtıl Length: 16mt

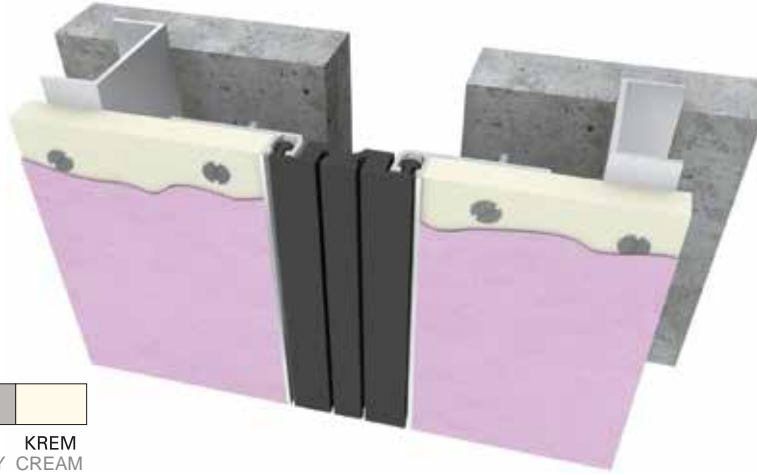

FİTİL RENKLERİ  
COLOURS OF INSERT

SIYAH	GİRİ	KREM
BLACK	GREY	CREAM

## AR202-051

### AÇIKLAMA / EXPLANATION

Sıva, yapıştırma seramik, alçıpan kaplamaları için uygun zemin fitili takılmış dekoratif dilatasyon profili.  
AR105, AR107 serisi zemin profilleri ile tam uyumlu.  
Decorative expansion joint profile suitable for under plaster.  
Compatible with AR105, AR107 series.

### TEKNİK ÖZELLİKLER / TECHNICAL FEATURES

Açıklık : 50 mm  
Width: 50 mm  
Yükseklik : 15 mm  
Height: 15 mm  
Hareket Kapasitesi: ± 10mm  
Movement Capacity: ± 10mm  
Profil Boyu: 3mt.  
Profile Length: 3mt

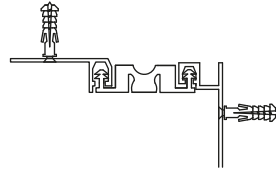

AR202-051 KÖŞE DETAYI  
AR202-051 CORNER DETAIL

### ALÇIPAN ASMA TAVAN VE BÖLME DUVAR DİLATASYON DETAYI DRYWALL SUSPENDED CEILING AND PARTITION WALL DILATATION DETAILS

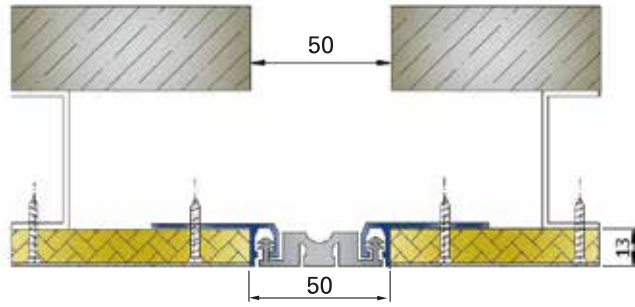

## AR202-050

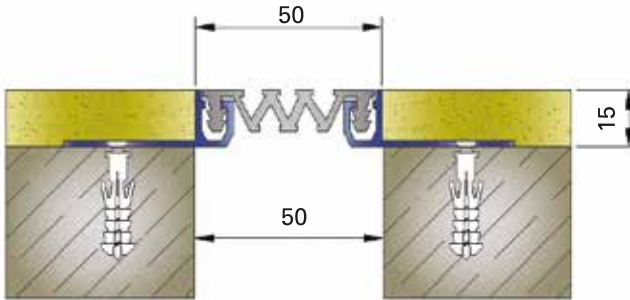

### AÇIKLAMA / EXPLANATION

Sıva, yapıştırma seramik, alçıpan kaplamaları için uygun dekoratif dilatasyon profili.  
Decorative joint profile suitable for under plaster.

### TEKNİK ÖZELLİKLER

Açıklık : 50 mm  
Width: 50 mm  
Yükseklik : 15 mm  
Height: 15 mm  
Hareket Kapasitesi: ± 20mm  
Movement Capacity: ± 20mm  
Profil Boyu: 3mt.  
Profile Length: 3mt  
AR105, AR107 serisi zemin profili ile tam uyumlu  
Compatible with AR105, AR107 series

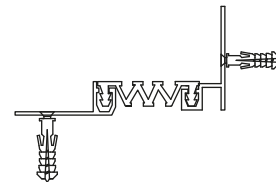

AR202-050 KÖŞE DETAYI  
AR202-050 CORNER DETAIL

## AR203-050 H:20 mm

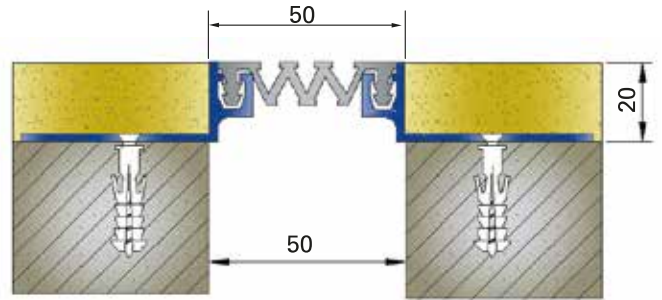

### AÇIKLAMA / EXPLANATION

Sıva, giydirmeye cephelerde granit, yapıştırma seramik v.b. için kaplama altı dilatasyon profili.  
Decorative joint profile suitable for under plaster.

### TEKNİK ÖZELLİKLER

Açıklık : 50 mm  
Width: 50 mm  
Yükseklik : 20 mm  
Height: 20 mm  
Hareket Kapasitesi: ± 20mm  
Movement Capacity: ± 20mm  
Profil Boyu: 3mt.  
Profile Length: 3mt  
AR105, AR107 serisi zemin profili ile tam uyumlu  
Compatible with AR105, AR107 series

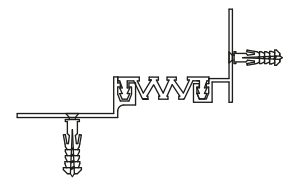

AR203-050 KÖŞE DETAYI  
AR203-050 CORNER DETAIL



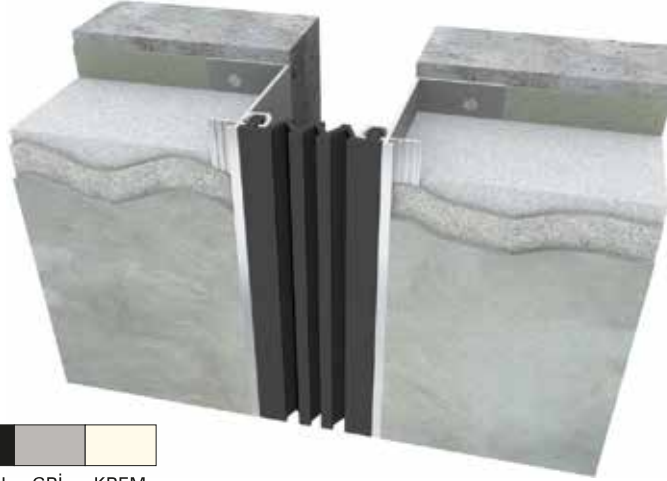

FİTİL RENKLERİ  
COLOURS OF INSERT

SIYAH	GRİ	KREM
BLACK	GREY	CREAM

### AR212-050

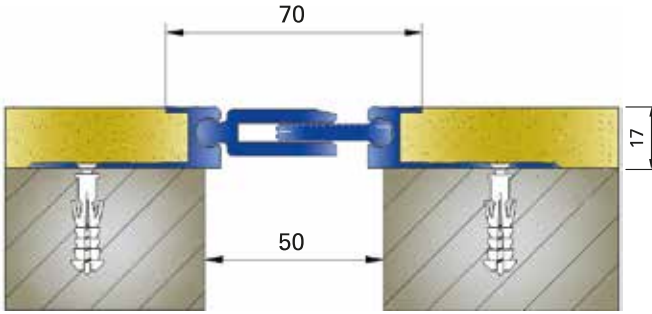

#### AÇIKLAMA / EXPLANATION

AR308-050 zemin dilatasyon profili ile uyumlu duvar tavan dilatasyon profili.  
Wall and corner joint profile compatible with AR308-050 floor profile.

#### TEKNİK ÖZELLİKLER / TECHNICAL FEATURES

Açıklık : 50 mm  
Width: 50 mm  
Yükseklik : 17 mm  
Height: 17 mm  
Hareket Kapasitesi:  $\pm 10$ mm  
Movement Capacity:  $\pm 10$ mm  
Profil Boyu: 3mt.  
Profile Length: 3mt

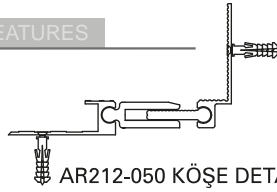
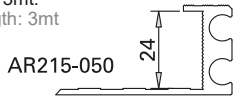

AR212-050 KÖŞE DETAYI  
AR212-050 CORNER DETAIL

Doğal granit ile kaplı giydirme duvar ve cepheler için uygun profil  
It can be used for natural stone on wall

### AR209-050

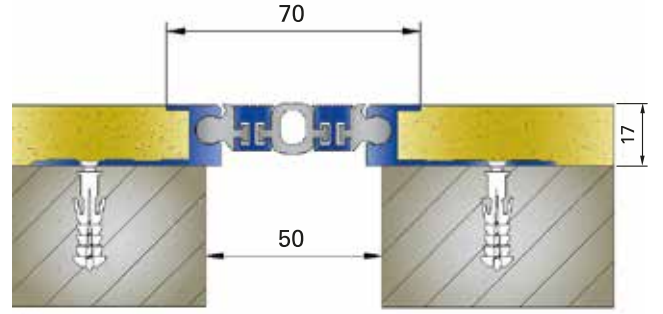

#### AÇIKLAMA / EXPLANATION

Sıva, seramik, alçıpan bölme duvar ve asma tavan için uygun dekoratif dilatasyon profili. Profil montajlı olarak sevk edilir.  
Joint profile suitable for under plaster.

#### TEKNİK ÖZELLİKLER / TECHNICAL FEATURES

Açıklık : 50 mm  
Width: 50 mm  
Yükseklik : 17 mm  
Height: 17 mm  
AR301 serisi zemin dilatasyon profilleri ile tam uyumlu  
Compatible with AR301 series  
Hareket Kapasitesi:  $\pm 10$ mm  
Movement Capacity:  $\pm 10$ mm  
Profil Boyu: 3mt.  
Profile Length: 3mt

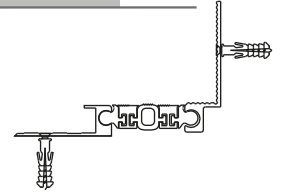

AR209-050 KÖŞE DETAYI  
AR209-050 CORNER DETAIL

### AR221-050

#### AÇIKLAMA / EXPLANATION

Isı yalıtımlı dış cephelerde kullanılan dilatasyon profili.  
Joint profile suitable for under plaster. It is used for heat isolated buildings.

#### TEKNİK ÖZELLİKLER / TECHNICAL FEATURES

Açıklık : 50 mm  
Width: 50 mm  
Yükseklik : 50+5 mm  
Height: 50+5 mm  
Hareket Kapasitesi:  $\pm 20$ mm  
Movement Capacity:  $\pm 20$ mm  
Profil Boyu: 3mt.  
Profile Length: 3mt

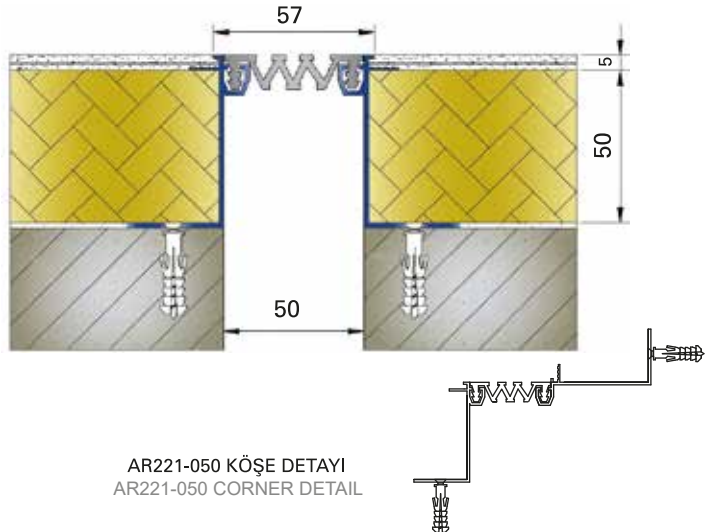

AR221-050 KÖŞE DETAYI  
AR221-050 CORNER DETAIL

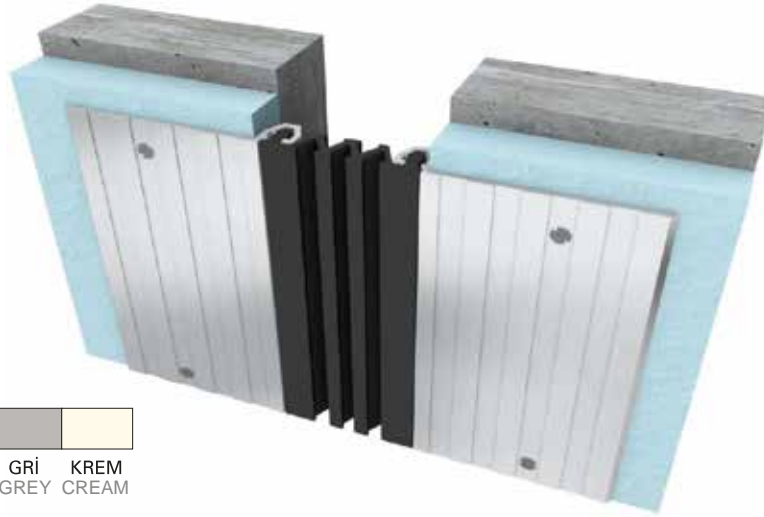

FİTİL RENKLERİ  
COLOURS OF INSERT

■	■	■
SİYAH	GİRİ	KREM
BLACK	GREY	CREAM

## AR252-050

### AÇIKLAMA / EXPLANATION

Eloksalli, sıva ve brüt beton üstü duvar tavan dilatasyon profili.  
Anodised joint profile suitable for over finishing.

### TEKNİK ÖZELLİKLER / TECHNICAL FEATURES

Açıklık : 50 mm  
Width: 50 mm  
Derinlik : 15 mm  
Depth: 15 mm  
AR105, AR107, AR151 serisi dilatasyon profilleri ile tam uyumlu duvar tavan dilatasyon profili  
Compatible with AR105, AR107, AR151 series  
Hareket Kapasitesi: ± 20mm  
Movement Capacity: ± 20mm  
Profil Boyu: 3mt.  
Profile Length: 3mt

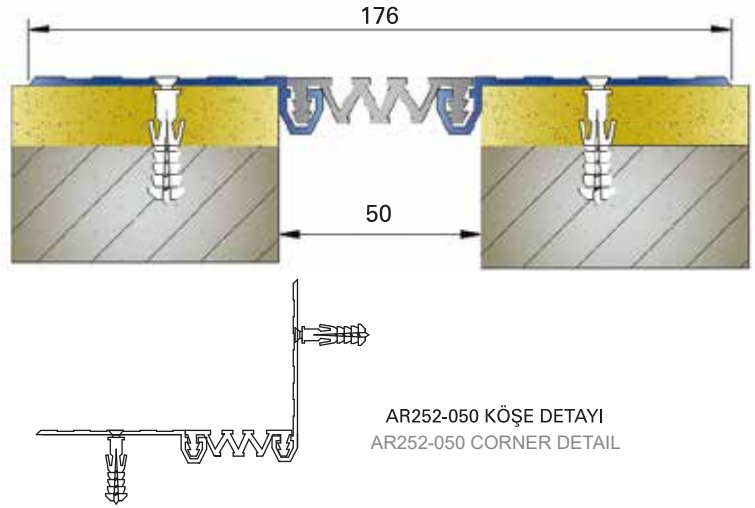

AR252-050 KÖŞE DETAYI  
AR252-050 CORNER DETAIL

## AR254-050

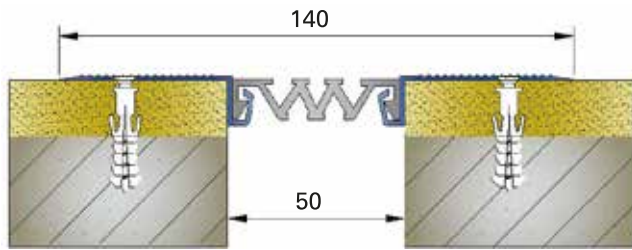

### AÇIKLAMA / EXPLANATION

Eloksalsiz sıva üstü duvar tavan dilatasyon profili.  
Non anodised joint profile for over finishing.

### TEKNİK ÖZELLİKLER

Açıklık : 50 mm  
Width: 50 mm  
Derinlik : 12,5 mm  
Depth: 12,5 mm  
Hareket Kapasitesi: ± 20mm  
Movement Capacity: ± 20mm  
Profil Boyu: 3mt.  
Profile Length: 3mt  
Epdm fitil yuvaya sürülerek takılır  
Epdm insert is installed by pushing  
Compatible with AR154

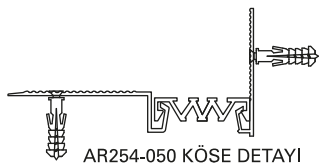

AR254-050 KÖŞE DETAYI  
AR254-050 CORNER DETAIL

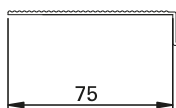

AR255-050  
Pahlı kolonlarda kullanılabilen geniş yan kanatlı dilatasyon profili (üst genişlik : 200 mm)  
With wide side profile it can be used for columns to cover both sides

## AR259-050

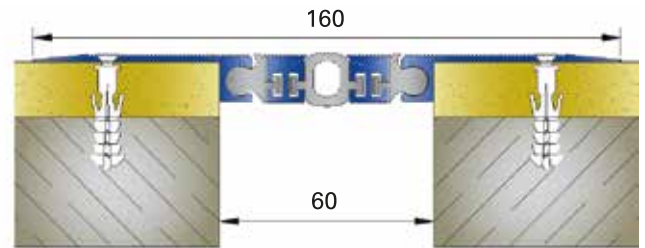

### AÇIKLAMA / EXPLANATION

Sıva ve brüt beton üstü duvar tavan dilatasyon profili  
Vida delikleri açılmış. Profil montajlı olarak sevk edilir.  
Non anodised joint profile for over finishing with screw holes.  
Profile is delivered in assembled.

### TEKNİK ÖZELLİKLER

Açıklık : 60 mm  
Width: 60 mm  
Derinlik : 15 mm  
Depth: 15 mm  
Hareket Kapasitesi: ± 10mm  
Movement Capacity: ± 10mm  
Profil Boyu: 3mt.  
Profile Length: 3mt  
AR172-050 ve AR301-050 ile tam uyumlu duvar tavan dilatasyon profili.  
Compatible with AR172-050 and AR301 series

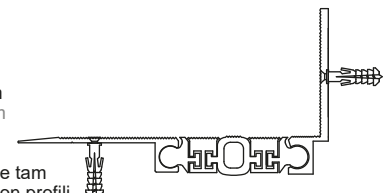

AR259-050 KÖŞE DETAYI  
AR259-050 CORNER DETAIL

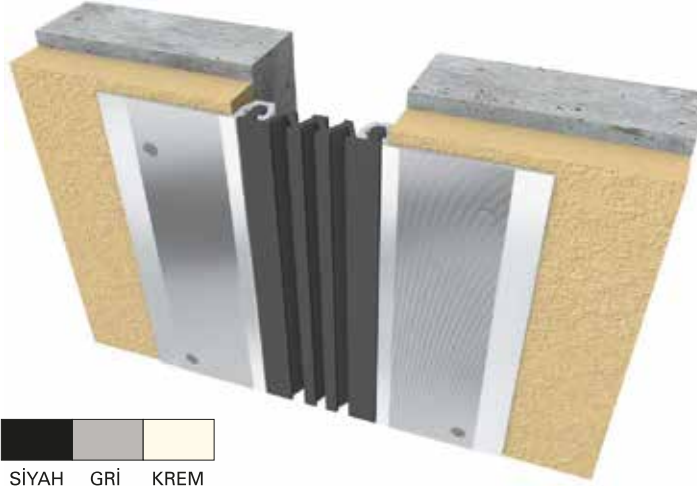

**AR261-050**

**AR262-051**

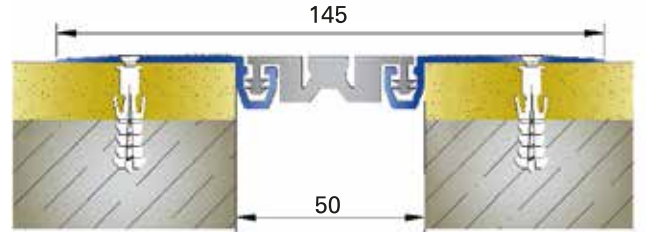
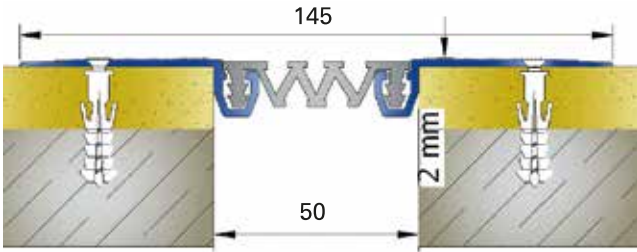

**AÇIKLAMA / EXPLANATION**

Eloksalli, vida delikli, sıva ve brüt beton üstü duvar tavan dilatasyon profili.  
Anodised joint profile over finishing with screw holes.

**AÇIKLAMA / EXPLANATION**

Eloksalli, dekoratif, vida delikli, sıva ve brüt beton üstü duvar tavan dilatasyon profili.  
Anodised joint profile over finishing with screw holes.

**TEKNİK ÖZELLİKLER / TECHNICAL FEATURES**

Açıklık : 50 mm  
Width: 50 mm  
Derinlik : 15 mm  
Depth: 15 mm  
Hareket Kapasitesi: ± 20mm  
Movement Capacity: ± 20mm  
Profil Boyu: 3mt.  
Profile Length: 3mt  
AR153-050, AR107 serisi ile tam uyumlu  
Compatible with AR105, AR107, AR153 series

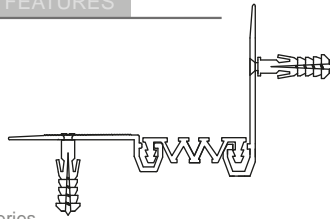

AR261-050 KÖŞE DETAYI  
AR261-050 CORNER DETAIL

**TEKNİK ÖZELLİKLER / TECHNICAL FEATURES**

Açıklık : 50 mm  
Width: 50 mm  
Derinlik : 15 mm  
Depth: 15 mm  
Hareket Kapasitesi: ± 10mm  
Movement Capacity: ± 10mm  
Profil Boyu: 3mt.  
Profile Length: 3mt  
AR153-050, AR107 serisi ile tam uyumlu  
Compatible with AR105, AR107, AR153 series

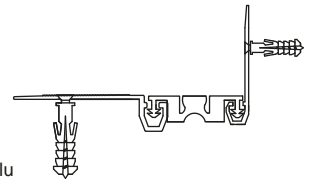

AR262-051 KÖŞE DETAYI  
AR262-051 CORNER DETAIL

**AR262-050**

**AÇIKLAMA / EXPLANATION**

Eloksalli, vida delikli, sıva ve brüt beton üstü duvar tavan dilatasyon profili.  
Anodised joint profile over finishing with screw holes.

**TEKNİK ÖZELLİKLER / TECHNICAL FEATURES**

Açıklık : 50 mm  
Width: 50 mm  
Derinlik : 15 mm  
Depth: 15 mm  
Hareket Kapasitesi: ± 20mm  
Movement Capacity: ± 20mm  
Profil Boyu: 3mt.  
Profile Length: 3mt  
AR153-050 ve AR107 serisi ile tam uyumlu  
Compatible with AR153-050, AR107 series

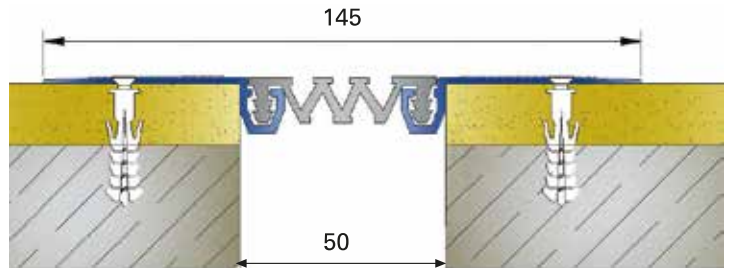

AR262-050 KÖŞE DETAYI  
AR262-050 CORNER DETAIL

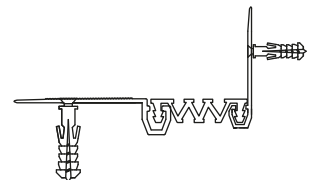





## AR281-050

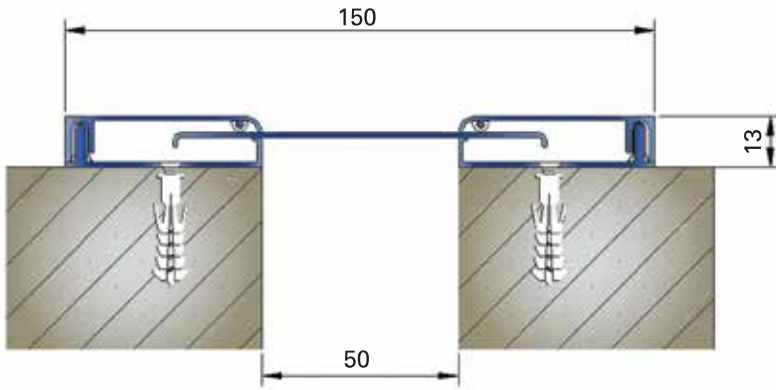

### AÇIKLAMA / EXPLANATION

5cm açıklık için sismik kaplama üstü duvar tavan dilatasyon profili  
50 cm ara ile kullanılan çelik yaylara üst kapak bastırılarak takılır.  
Wall / Ceiling Seismic Joint profile for 5cm expansion joint gap.  
Top cover is fixed with steel springs.

### TEKNİK ÖZELLİKLER / TECHNICAL FEATURES

Açıklık : 50 mm  
Width: 50 mm  
Yükseklik : 13 mm  
Height: 13 mm  
Hareket Kapasitesi:  $\pm 40$ mm  
Movement Capacity:  $\pm 40$ mm



## AR281-050

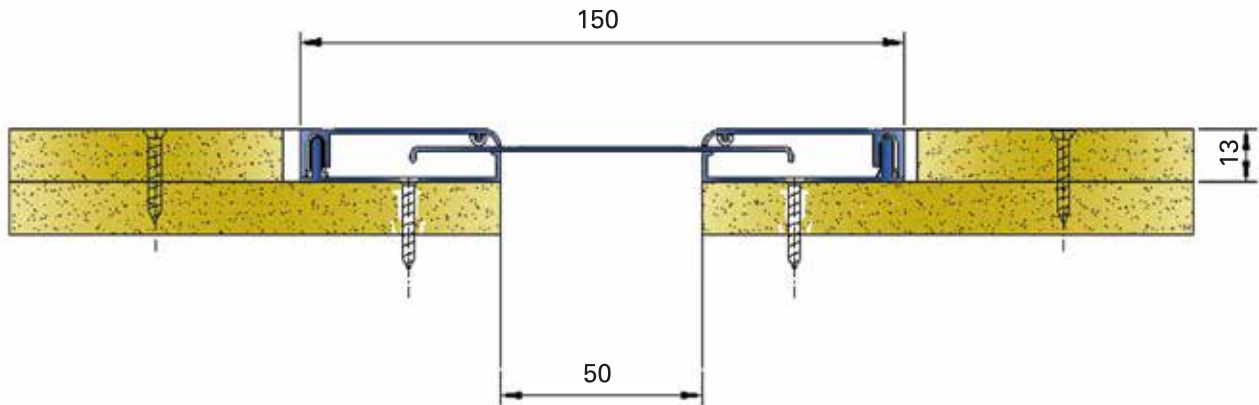

### AÇIKLAMA / EXPLANATION

5 cm açıklık için sismik kaplama altı duvar tavan dilatasyon profili.  
Özellikle alçıpan asma tavan ve bölme duvar uygulamaları için kullanılabilir.  
50 cm ara ile kullanılan çelik yaylara üst kapak bastırılarak takılır.

Wall and ceiling seismic joint profile which is used for 5 cm gap.  
Especially, it can be used in the applications or drywall ceiling and demontable wall. Top cover is fixed with steel springs.

### TEKNİK ÖZELLİKLER / TECHNICAL FEATURES

Açıklık : 50 mm  
Width: 50 mm  
Yükseklik : 13 mm  
Height: 13 mm  
Hareket Kapasitesi:  $\pm 40$ mm  
Movement Capacity:  $\pm 40$ mm



**AR281-050 K**

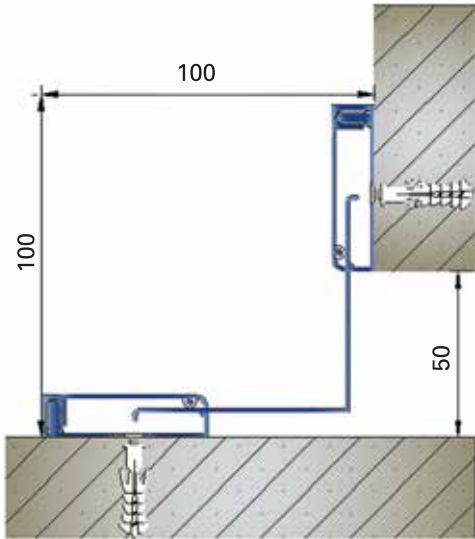

**AÇIKLAMA / EXPLANATION**

5cm açıklık için sismik kaplama üstü duvar tavan köşe dilatasyon profili. 50cm ara ile kullanılan çelik yaylara üst kapak bastırılarak takılır.

Wall and ceiling seismic joint profile for 5cm expansion joint gap. Top cover is fixed with steel springs.

**TEKNİK ÖZELLİKLER / TECHNICAL FEATURES**

Açıklık : 50 mm  
Width: 50 mm  
Yükseklik : 13 mm  
Height: 13 mm  
Hareket Kapasitesi: ± 20mm  
Movement Capacity: ± 20mm

**AR281-050 K**

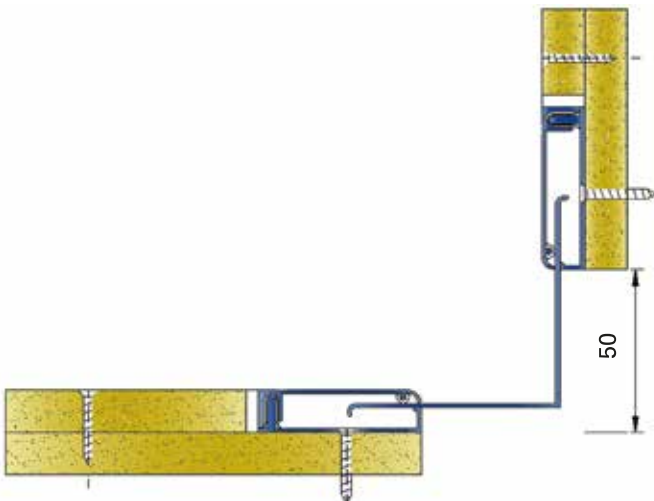

**AÇIKLAMA / EXPLANATION**

5cm açıklık için sismik kaplama altı duvar tavan köşe dilatasyon profili. Alçıpan asma tavan ve bölme duvar uygulamaları için kullanılabilir. 50cm ara ile kullanılan çelik yaylara üst kapak bastırılarak takılır.

Wall and ceiling seismic joint profile which is used for 5cm gap. Especially, it can be used in the application or drywall ceiling and demountable wall. Top cover is fixed with steel springs.

**TEKNİK ÖZELLİKLER / TECHNICAL FEATURES**

Açıklık : 50 mm  
Width: 50 mm  
Yükseklik : 13 mm  
Height: 13 mm  
Hareket Kapasitesi: ± 20mm  
Movement Capacity: ± 20mm



AR60 DT (Duvar Tavan)  
AR60 DT (Wall / Ceiling)

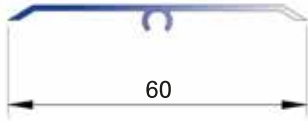

AR100 ZD (Zemin)  
AR100 ZD (Floor)

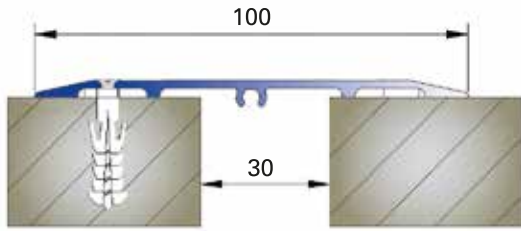

AR100 DT (Duvar Tavan)  
AR100 DT (Wall / Ceiling)

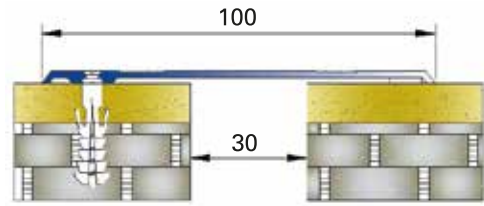

AR120 ZD (Zemin)  
AR120 ZD (Floor)

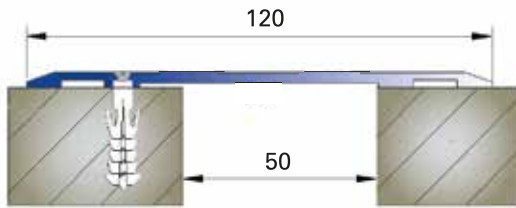

AR120 DT (Duvar Tavan)  
AR120 DT (Wall / Ceiling)

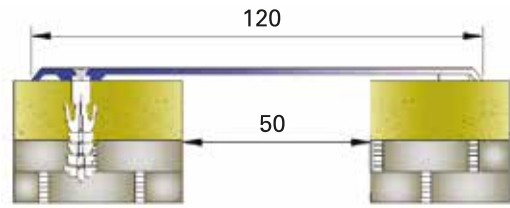

AR4070K (Köşe Kapak)  
AR4070K (Corner Cover)

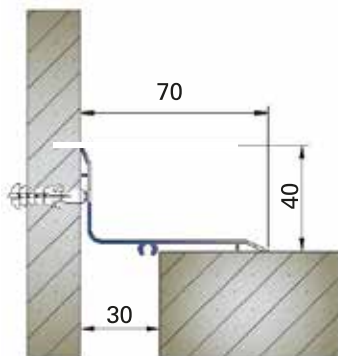

AR5080K (Köşe Kapak)  
AR5080K (Corner Cover)

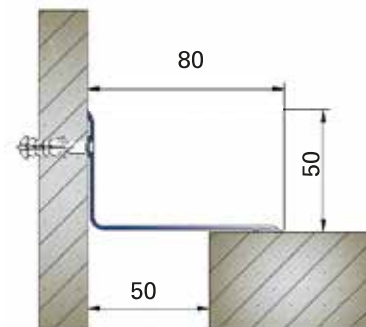

AÇIKLAMA / EXPLANATION

Zemin kapak profillerimiz bir taraftan 35cm ara ile havşa başlı vida delikli, duvar tavan profillerimiz bir taraftan 45cm ara ile havşa başlı vida delikli ve yüzeyi karamaya karşı eloksallıdır. Standart profillerimizin üretim boyları 3 metredir.

Anodised joint profiles with screw holes from one side. The length of our standart profiles are 3 meters.



**AR150 ZD (Zemin)**  
AR150 ZD (Floor)

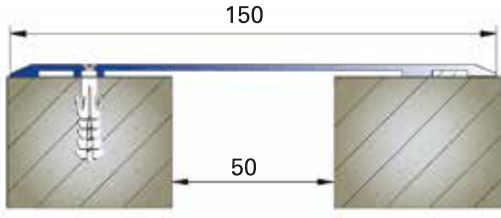

**AR150 DT (Duvar Tavan)**  
AR150 DT (Wall / Ceiling)

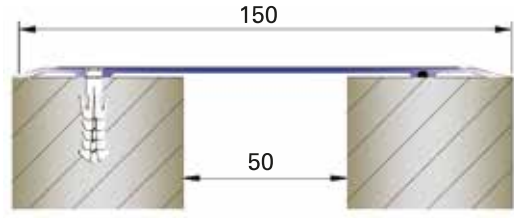

**AR200 ZD (Zemin)**  
AR200 ZD (Floor)

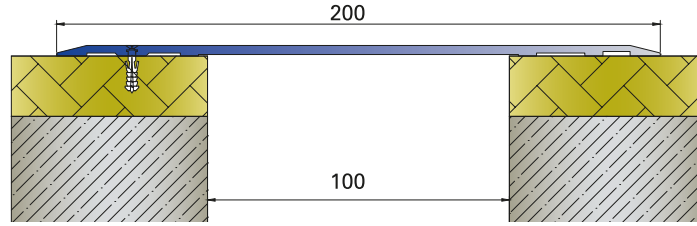

**AR200 DT (Duvar - Tavan)**  
AR200 DT (Wall / Ceiling)

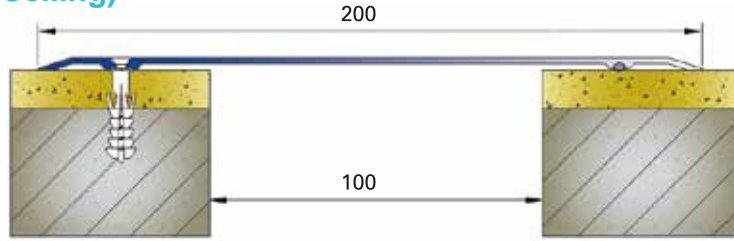

**AR50100K (Köşe Kapak)**  
AR50100K (Corner Cover)

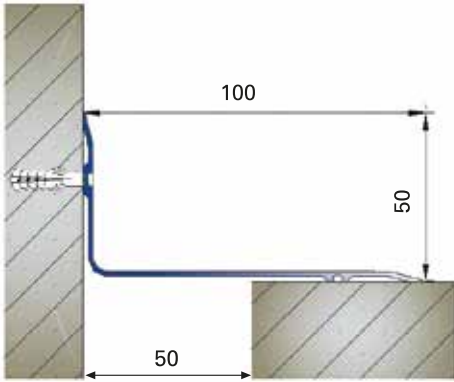

**AR50150K (Köşe Kapak)**  
AR50150K (Corner Cover)

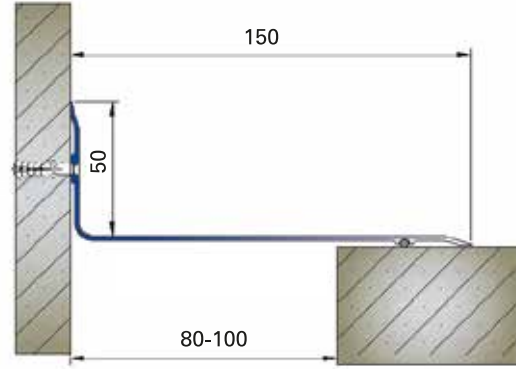

**AR50200K (Köşe Kapak)**  
AR50200K (Corner Cover)

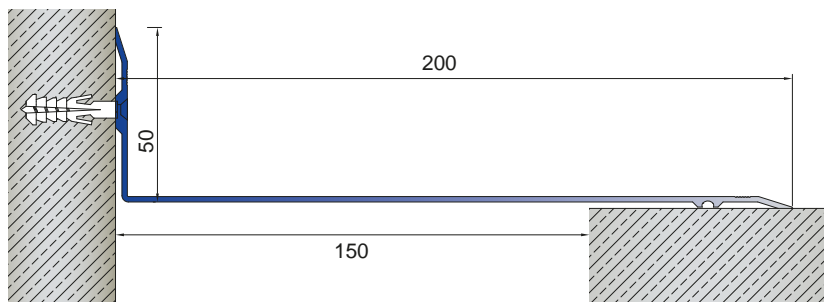

AÇIKLAMA / EXPLANATION

Zemin kapak profillerimiz bir taraftan 35cm ara ile havşa başlı vida delikli, duvar tavan profillerimiz bir taraftan 45cm ara ile havşa başlı vida delikli ve yüzeyi kararmaya karşı eloksal kaplamalıdır. Standart profillerimizin üretim boyları 3 metredir.  
Cover joint profiles are fixed from one side. It is covered anodise against surface corrosion. The length of production of standart profiles are 3 meters.

AR151 DT (Duvar Tavan)  
AR151 DT (Wall / Ceiling)

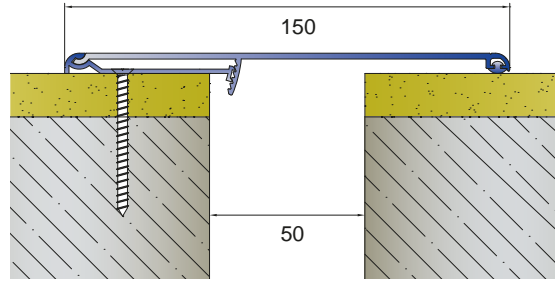

AR201 DT (Duvar Tavan)  
AR201 DT (Wall / Ceiling)

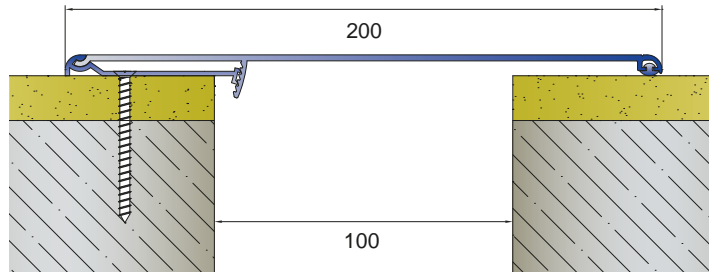

AR50 151K & AR50 101K (Köşe Kapak )  
AR50 151K & AR50 101K (Corner Cover)

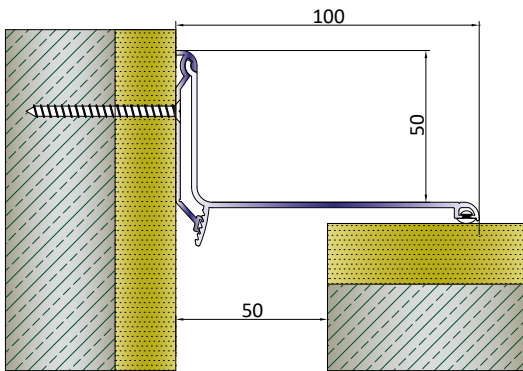

AR50 101K

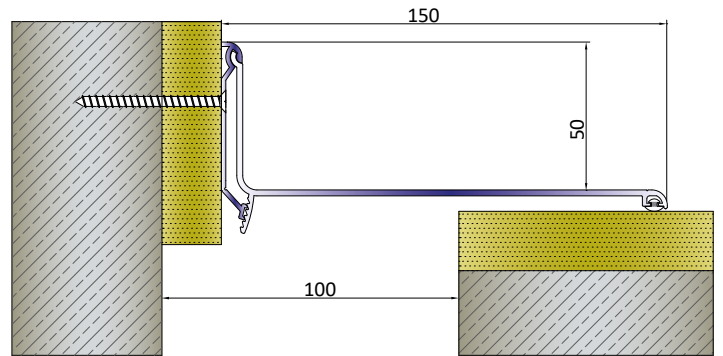

AR50 151K

AÇIKLAMA / EXPLANATION

Gizli vidalı duvar tavan kapak sistemleri tek taraftan vida ile duvara sabitlenmekte, üst kapak takılarak dekoratif bir bitiş sağlanmaktadır. Özellikle iç mekanlarda kullanılmaktadır.

Wall and ceiling expansion joint profiles are installed from one side with hidden screw. Especially is recommended for interior areas.

**AR350 ZD (Zemin)**  
**AR350 ZD (Floor)**

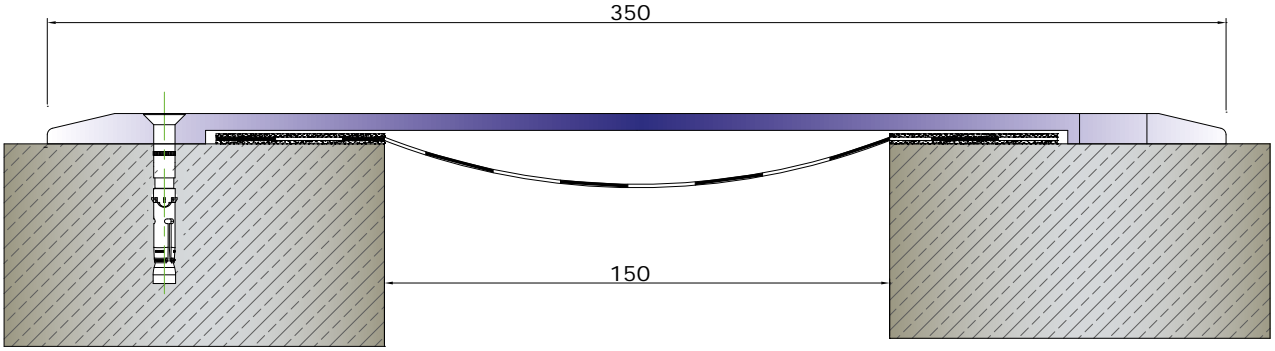

**AR151 ZD (Zemin)**  
**AR151 ZD (Floor)**

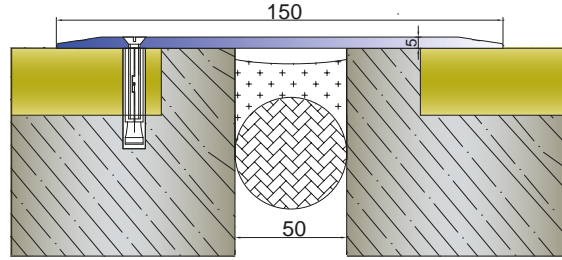

**AÇIKLAMA / EXPLANATION**

Yoğun yaya ve hafif taşıt trafiğine maruz alanlarda kullanılan kaplama üzeri kapak profilidir.  
This cover joint profile is used for intensive pedestrian traffic and light car traffic.

**AR250 DT (Duvar - Tavan)**  
**AR250 DT (Wall / Ceiling)**

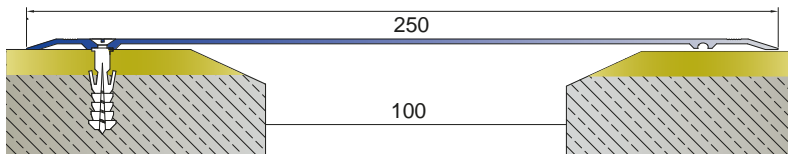

**AR270 DT + BTA (Duvar - Tavan)**  
**AR270 DT + BTA (Wall / Ceiling)**

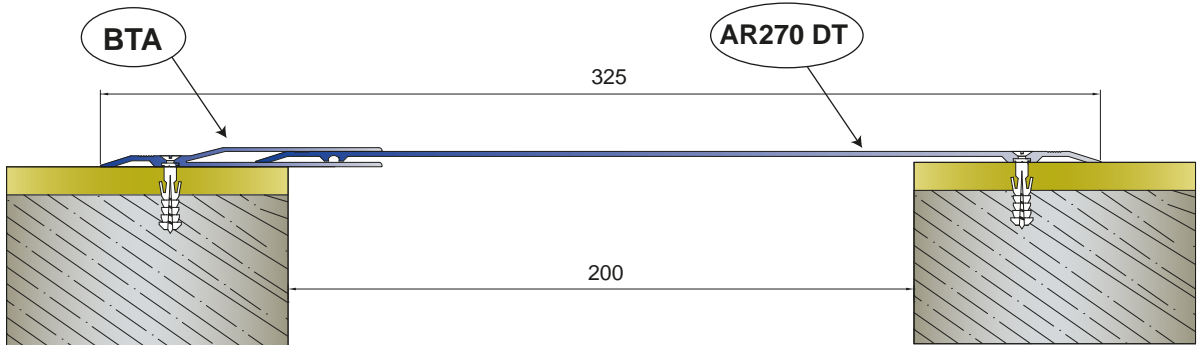

**AÇIKLAMA / EXPLANATION**

Geniş tip kapak profilleri bitiş aparatı ile birlikte ya da aparatsız olarak geniş açıklıkları geçmek için kullanılırlar.  
Wide cover joint profiles are used for to pass big span expansion joint with special ending parts. It can be used also seperately.

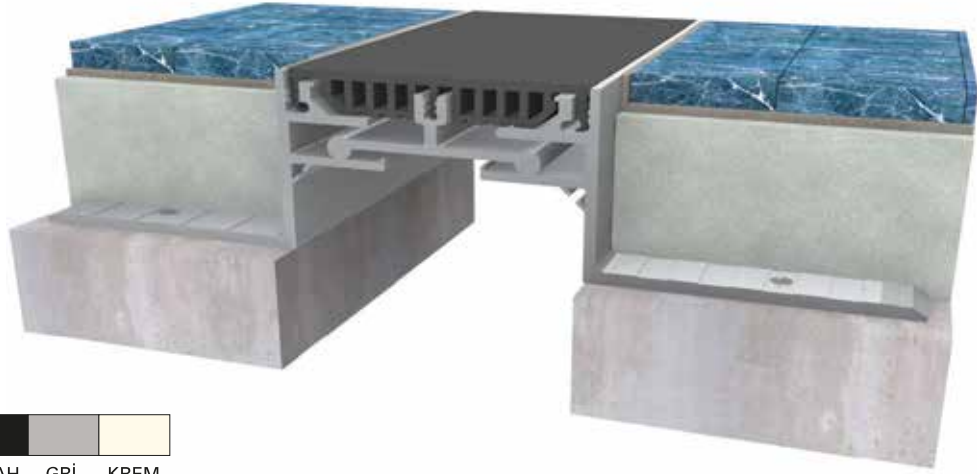

FİTİL RENKLERİ  
COLOURS OF INSERT

■	■	■
SIYAH	GRİ	KREM
BLACK	GREY	CREAM

## AR109-080

### AÇIKLAMA / EXPLANATION

Düz üst yüzeyli kaplama altı zemin dilatasyon profili.  
Joint profile covered with smooth surface rubber insert.

### TEKNİK ÖZELLİKLER / TECHNICAL FEATURES

Açıklık : 80 mm  
Width: 80 mm  
Yükseklik : 50 mm  
Height: 50 mm  
Yaya trafiğine dayanıklı  
Resistant to pedestrian traffic  
Hareket Kapasitesi: ± 10mm  
Movement Capacity: ± 10mm  
Profil Boyu: 3mt.  
Profile Length: 3mt

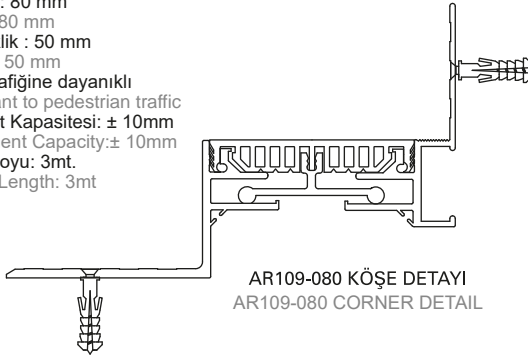

AR109-080 KÖŞE DETAYI  
AR109-080 CORNER DETAIL

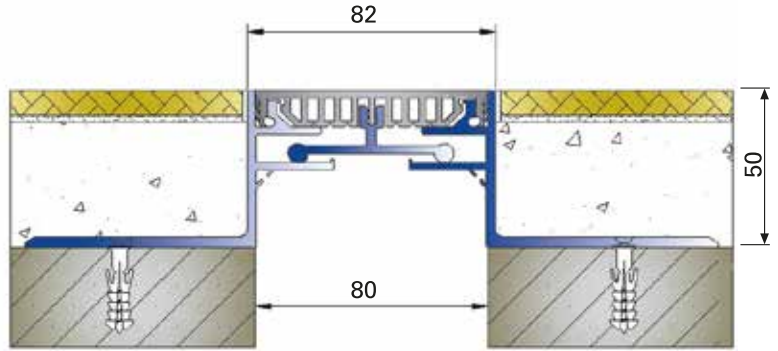

## AR109-081

### AÇIKLAMA / EXPLANATION

Düz üst yüzeyli seramik altı zemin dilatasyon profili.  
Joint profile covered with smooth surface rubber insert.  
Suitable for under ceramic.

### TEKNİK ÖZELLİKLER / TECHNICAL FEATURES

Açıklık : 80 mm  
Width: 80 mm  
Yükseklik : 12 mm  
Height: 12 mm  
Yaya trafiğine dayanıklı  
Resistant to pedestrian traffic  
Hareket Kapasitesi: ± 10mm  
Movement Capacity: ± 10mm

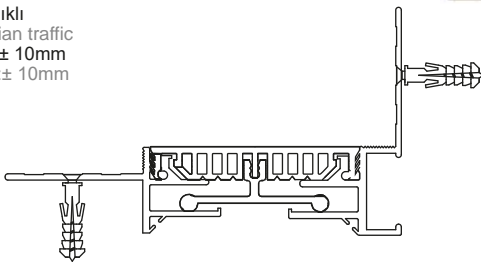

AR109-081 KÖŞE DETAYI  
AR109-081 CORNER DETAIL

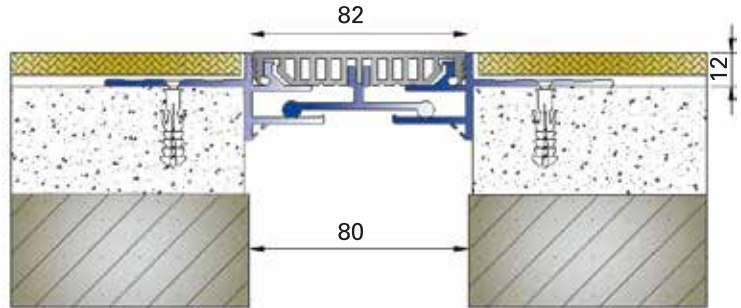



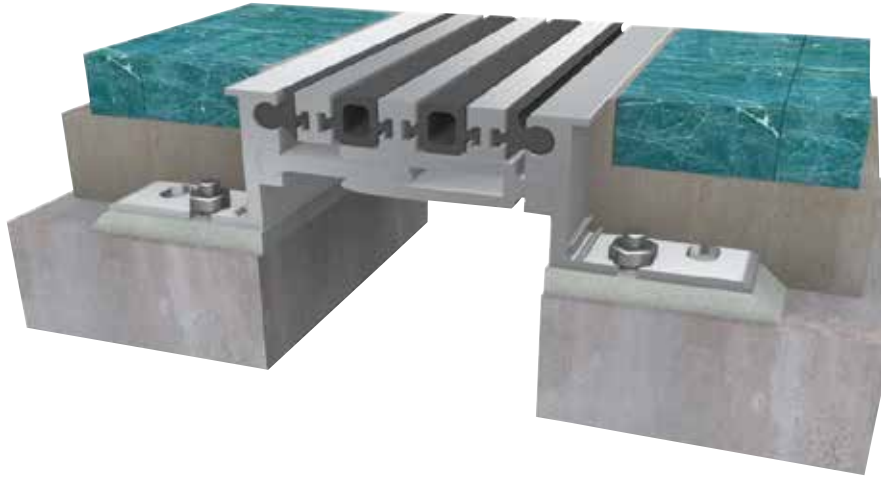

**AR302-080**
**AÇIKLAMA / EXPLANATION**

Her türlü zemin kaplamasına uygun dilatasyon profili.  
Montajlı olarak sevk edilir.  
It is suitable for all kinds of floor covering  
Profile is delivered in assembled.

**TEKNİK ÖZELLİKLER / TECHNICAL FEATURES**

Açıklık : 80 mm  
Width: 80 mm  
Yükseklik : 14-28-43-60 mm  
Height: 14-28-43-60 mm  
Hareket Kapasitesi:  $\pm 12$ mm  
Movement Capacity:  $\pm 12$ mm  
Profil Boyu: 3mt.  
Profile Length: 3mt  
3,5 ton araç 2,5 ton forklift  
trafiğine dayanıklı.  
Yan tırnağı dolayısıyla zemin  
kaplamasını kitler  
Resistant to 3,5 tones vehicle load  
and 2,5 tones forklift load

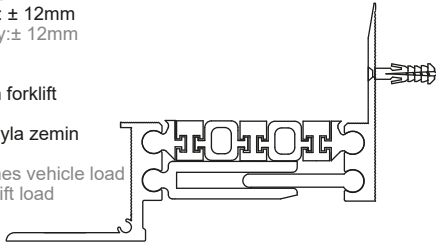

AR302-080 KÖŞE DETAYI  
AR302-080 CORNER DETAIL

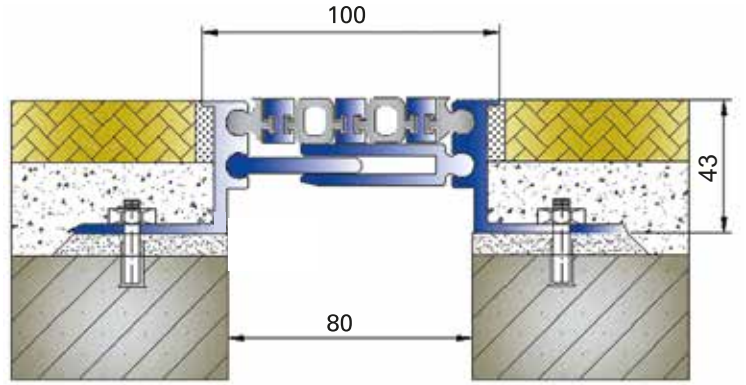

AR302-081 H:14  
AR302-082 H:28  
AR302-083 H:60

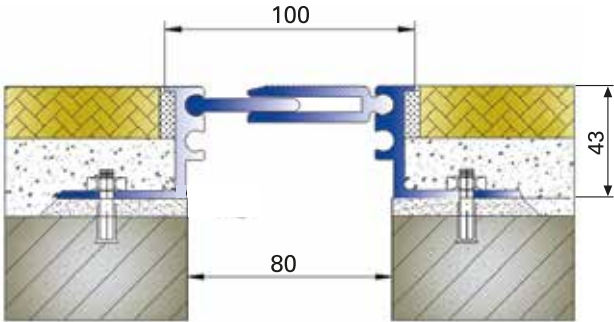
**AR309-080**

**AÇIKLAMA / EXPLANATION**

Kaplama altı zemin dilatasyon profili.  
Joint profile for under finishing.

**TEKNİK ÖZELLİKLER / TECHNICAL FEATURES**

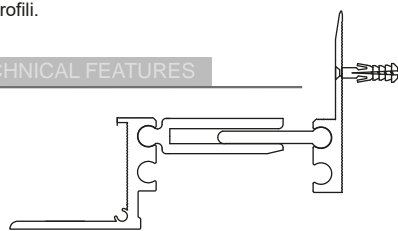
Açıklık : 80 mm  
Width: 80 mm  
Yükseklik : 14-28-43-60 mm  
Height: 14-28-43-60 mm  
Hareket Kapasitesi:  $\pm 12$ mm  
Movement Capacity:  $\pm 12$ mm  
Profil Boyu: 3mt.  
Profile Length: 3mt  
Yan tırnağı dolayısıyla zemin  
kaplamasını kitler  
It locks the floor overlay



AR309-080 KÖŞE DETAYI  
AR309-080 CORNER DETAIL

AR309-081 H:14 / AR309-082 H:28  
AR309-083 H:60

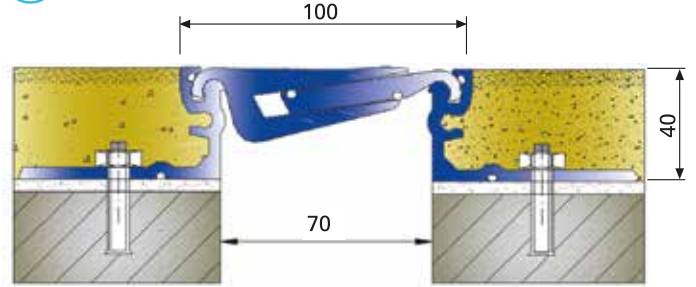
**AR712-080**

**AÇIKLAMA / EXPLANATION**

Endüstriyel tesisler, alışveriş merkezleri, hastaneler gibi yapılarda düz üst yüzeyi ve ağır trafiğe dayanıklı yapısı ile tercih edilir.  
This joint is suitable for industrial buildings, shopping malls, hospitals... etc. It's smooth surface and it is resistant to heavy traffic.

**TEKNİK ÖZELLİKLER / TECHNICAL FEATURES**

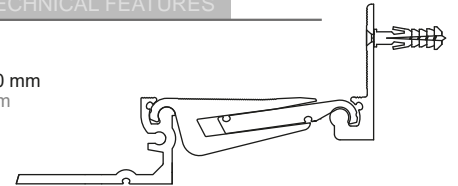
Açıklık : 70 mm  
Width: 70 mm  
Yükseklik : 17-30-40-50-60-70 mm  
Height: 17-30-40-50-60-70 mm  
Hareket Kapasitesi:  $\pm 16$ mm  
Movement Capacity:  $\pm 16$ mm  
Profil Boyu: 4mt.  
Profile Length: 4mt  
30 ton araç ve 6,5 ton forklift  
aks yüküne dayanıklı  
Resistant to 30 tones vehicle load  
and 6,5 ton forklift load.



AR712-080 KÖŞE DETAYI  
AR712-080 CORNER DETAIL

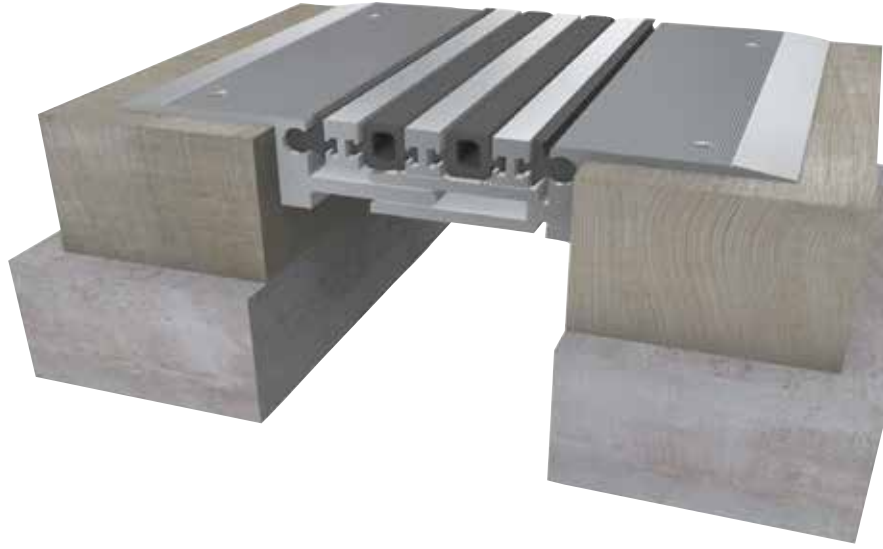

AR173-080

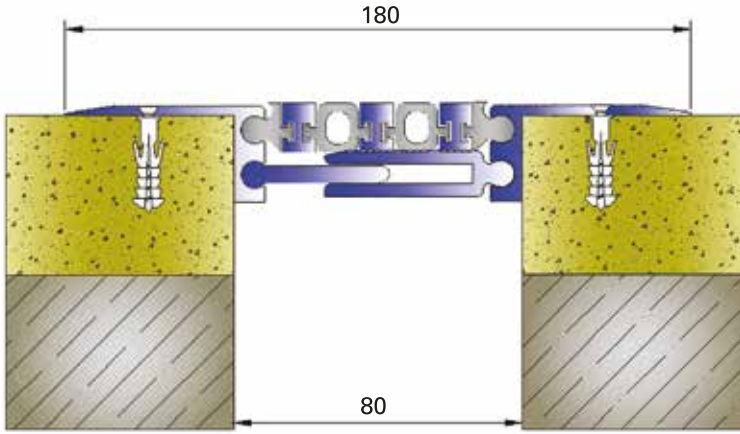

AÇIKLAMA / EXPLANATION

Granit, seramik, vinil, endüstriyel zemin v.b. kaplamalara uygun montaj delikleri açılmış zemin dilatasyon profili. Profil montajlı olarak sevk edilir.

Floor joint profile which has screw holes is suitable for overlays such as granite, ceramic, vinyl and industrial floor. It is delivered in assembled.

TEKNİK ÖZELLİKLER / TECHNICAL FEATURES

Açıklık : 80 mm  
Width: 80 mm  
Derinlik : 26 mm  
Depth: 26 mm  
2,5 ton araç trafiğine dayanıklı  
Resistant to the 2.5 tones vehicle traffic  
Hareket Kapasitesi: ± 12mm  
Movement Capacity: ± 12mm  
Profil Boyu: 3mt.  
Profile Length: 3mt

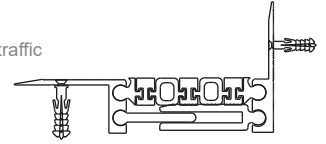

AR173-080 KÖŞE DETAYI  
AR173-080 CORNER DETAIL

AR763-080

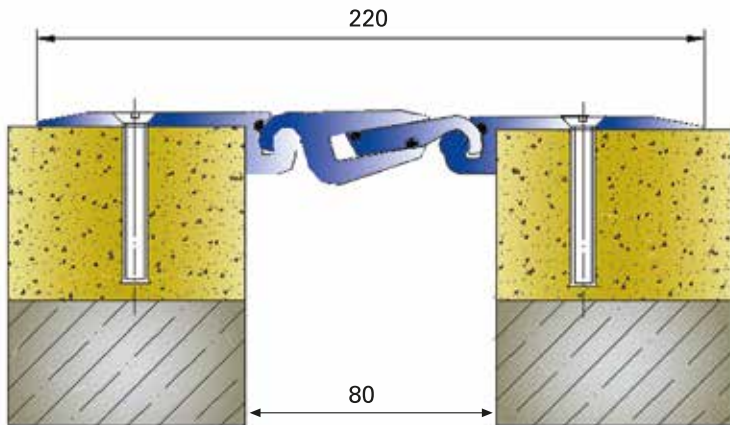

AÇIKLAMA / EXPLANATION

Endüstriyel zeminlerde kaplama üzeri, montaja uygun vida delikleri açılmış zemin dilatasyon profil. Profil montajlı olarak sevk edilir.

It is suitable for industrial floorings. It has also some strip over the profile against slipping.

TEKNİK ÖZELLİKLER / TECHNICAL FEATURES

Açıklık : 80 mm  
Width: 80 mm  
Derinlik : 20 mm  
Depth: 20 mm  
9 ton araç 3,5 ton forklift  
trafiğine dayanıklı  
Resistant to the 9 tones vehicle load  
and 3,5 ton forklift load  
Hareket Kapasitesi: ± 10mm  
Movement Capacity: ± 10mm  
Profil Boyu: 4mt.  
Profile Length: 4mt

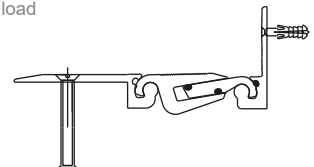

AR763-080 KÖŞE DETAYI  
AR763-080 CORNER DETAIL



## AR210-080

### AÇIKLAMA / EXPLANATION

Siva, seramik, alçıpan uygulamaları için kaplama altı duvar tavan dilatasyon profili.  
 Wall and ceiling joint profile for under plaster is suitable for ceramic and any other wall finishing material.

### TEKNİK ÖZELLİKLER / TECHNICAL FEATURES

Açıklık : 80 mm  
 Width: 80 mm  
 Yükseklik : 17 mm  
 Height: 17 mm  
 Hareket Kapasitesi:  $\pm 12$ mm  
 Movement Capacity:  $\pm 12$ mm  
 Profil Boyu: 3mt.  
 Profile Length: 3mt  
 AR302-080 serisi zemin dilatasyon profili ile tam uyumlu  
 Compatible with AR302-080 series.

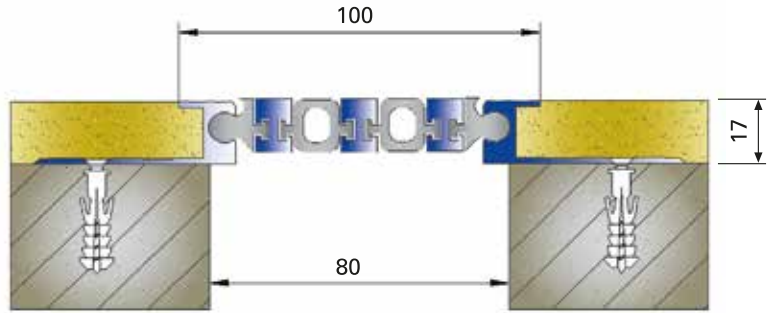
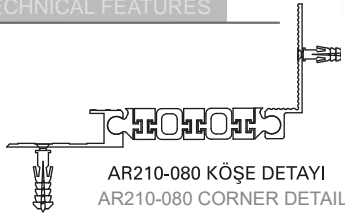

## AR215-080

### AÇIKLAMA / EXPLANATION

Siva, seramik, alçıpan uygulamaları için kaplama altı duvar tavan dilatasyon profili.  
 Wall and ceiling joint profile which is used for the applications of ceramic, plaster or suspended ceiling.

### TEKNİK ÖZELLİKLER / TECHNICAL FEATURES

Açıklık : 80 mm  
 Width: 80 mm  
 Yükseklik : 17 mm  
 Height: 17 mm  
 Hareket Kapasitesi:  $\pm 10$ mm  
 Movement Capacity:  $\pm 10$ mm  
 Profil Boyu: 3mt.  
 Profile Length: 3mt  
 AR109-080 serisi zemin dilatasyon profilleri ile tam uyumlu  
 Compatible with AR109-080 series.

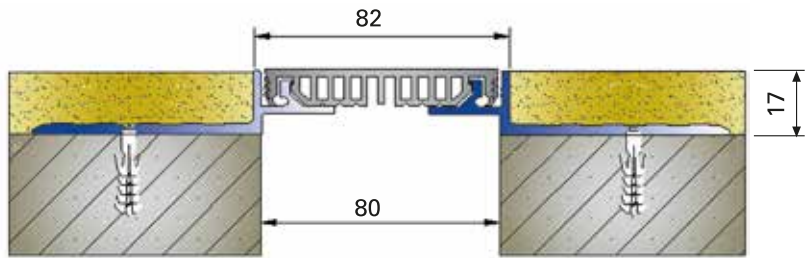
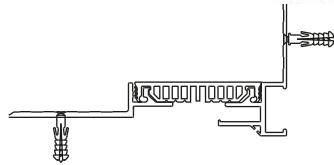

## AR259-080

### AÇIKLAMA / EXPLANATION

Siva üstü duvar tavan dilatasyon profili. Profil montajlı olarak sevk edilir.  
 Wall and ceiling joint profile for over finishing. It is delivered in assembled.

### TEKNİK ÖZELLİKLER / TECHNICAL FEATURES

Açıklık : 80 mm  
 Width: 80 mm  
 Derinlik : 15 mm  
 Depth: 15 mm  
 Hareket Kapasitesi:  $\pm 12$ mm  
 Movement Capacity:  $\pm 12$ mm  
 Profil Boyu: 3mt.  
 Profile Length: 3mt  
 AR302-080 ve AR173-080 serisi zemin dilatasyon profilleri ile tam uyumlu  
 Compatible with AR302-080 and AR173-080 series.

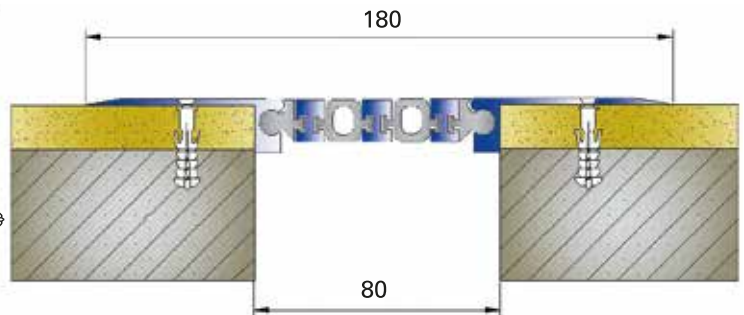
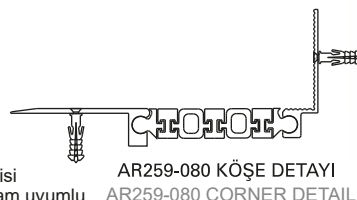



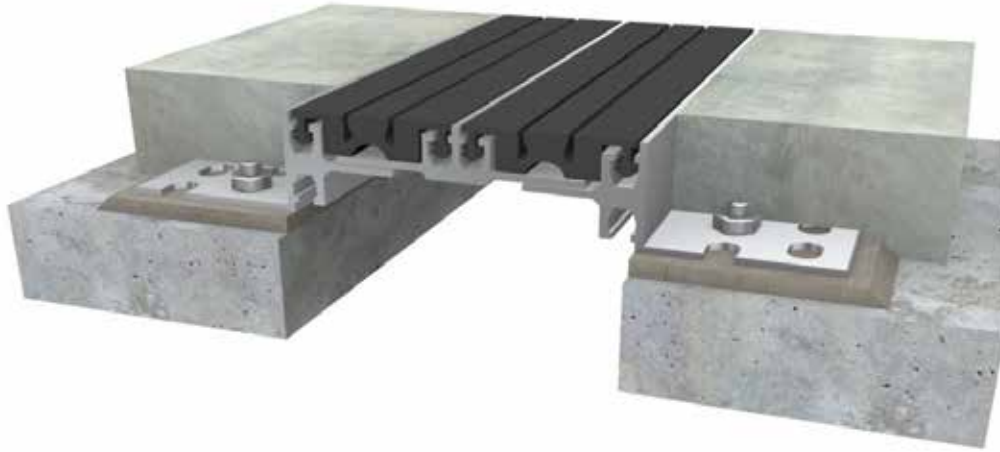

## AR106-100

### AÇIKLAMA / EXPLANATION

Kaplama altı zemin dilatasyon profili.  
Joint profile for under finishing.

### TEKNİK ÖZELLİKLER / TECHNICAL FEATURES

Açıklık : 100 mm

Width: 100 mm

Yükseklik : 30 mm

Height: 30 mm

Yaya trafiğine dayanıklı

Resistant to the pedestrian traffic

Haraket Kapasitesi:  $\pm 15$ mm

Movement Capacity:  $\pm 15$ mm

Profil Boyu: 3mt.

Profile Length: 3mt

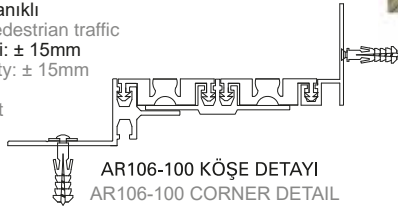

AR106-100 KÖŞE DETAYI  
AR106-100 CORNER DETAIL

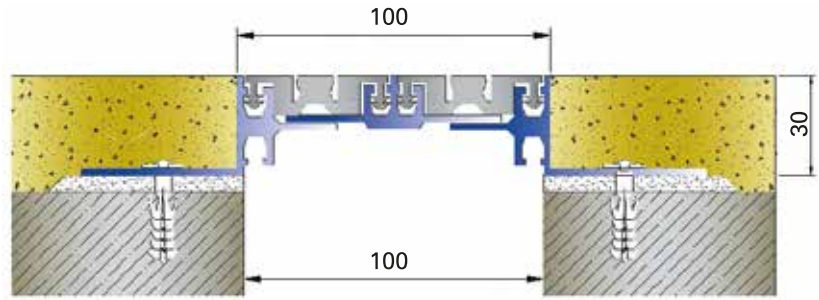

## AR304-100

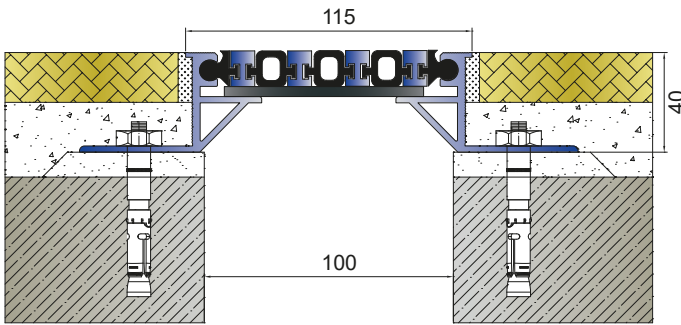

### AÇIKLAMA / EXPLANATION

Kaplama altı zemin dilatasyon profili.  
Joint profile for under finishing.

### TEKNİK ÖZELLİKLER / TECHNICAL FEATURES

Açıklık : 100 mm aralığında

Width: 100 mm

Yükseklik : 40 mm

Height: 40 mm

1,5 ton araç yüküne dayanıklı

Bu yük dayanımı dilatasyon açıklığı 100mm için geçerlidir.

Resistant to 1,5 tones vehicle load

This load resistant is acceptable for 100mm gap.

Haraket Kapasitesi:  $\pm 14$ mm

Movement Capacity:  $\pm 14$ mm

Profil Boyu: 3mt.

Profile Length: 3mt

## AR309-100

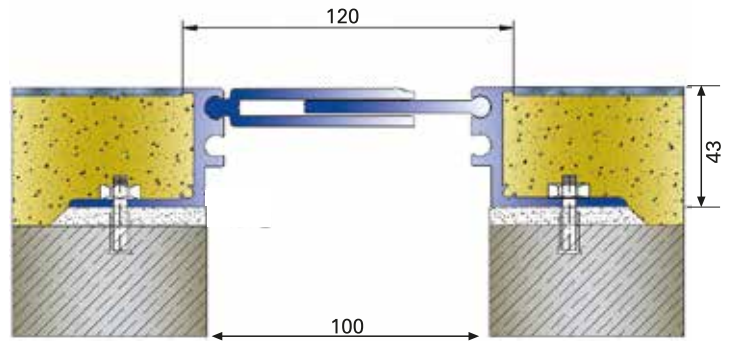

### AÇIKLAMA / EXPLANATION

Kaplama altı zemin dilatasyon profili.  
Joint profile for under finishing.

### TEKNİK ÖZELLİKLER / TECHNICAL FEATURES

Açıklık : 100 mm aralığında

Width: 100 mm

Yükseklik : 14-28-43-60 mm

Height: 14-28-43-60 mm

1,5 ton araç yüküne dayanıklı

Bu yük dayanımı dilatasyon açıklığı 100mm için geçerlidir.

Resistant to 1,5 tones vehicle load

This load resistant is acceptable for 100mm gap.

Haraket Kapasitesi:  $\pm 14$ mm

Movement Capacity:  $\pm 14$ mm

Profil Boyu: 3mt.

Profile Length: 3mt

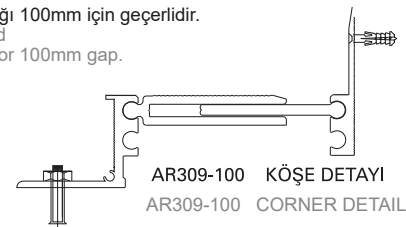

AR309-100 KÖŞE DETAYI  
AR309-100 CORNER DETAIL

AR309-101 H:14

AR309-102 H:28

AR309-103 H:60





## AR303-100

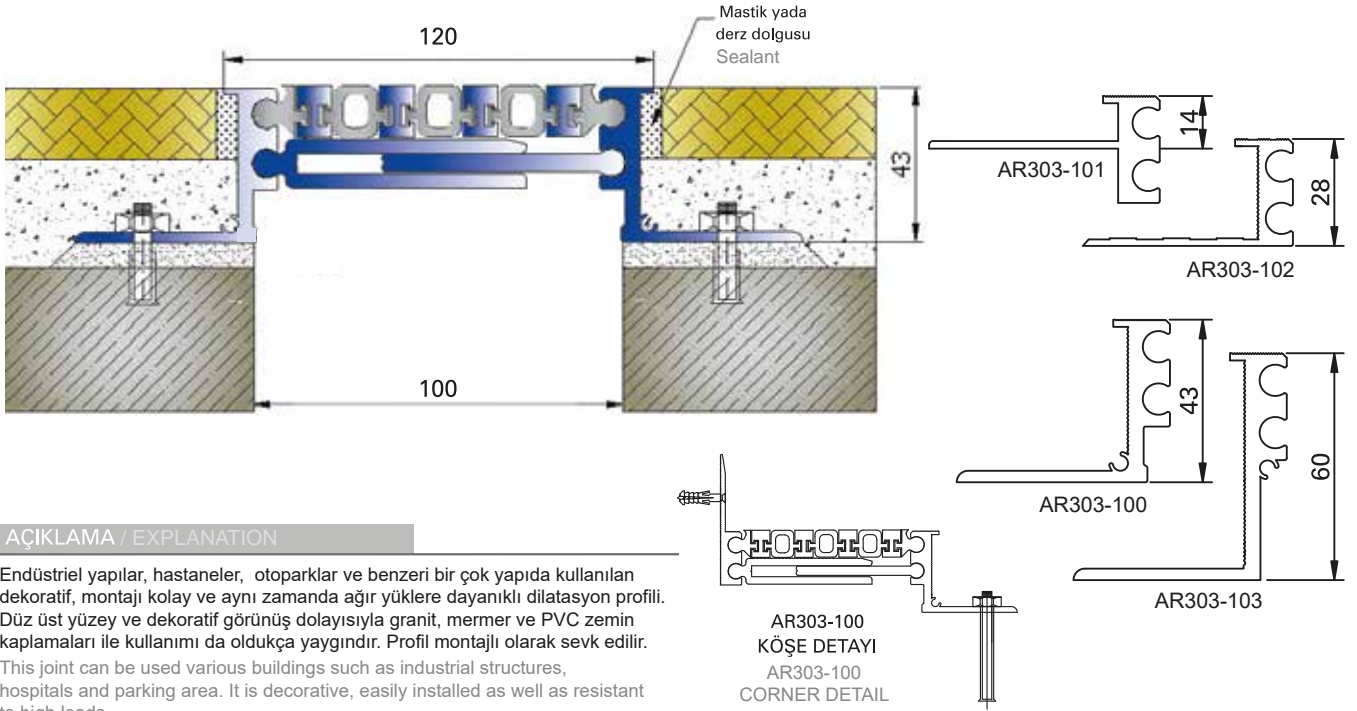

### AÇIKLAMA / EXPLANATION

Endüstriyel yapılar, hastaneler, otoparklar ve benzeri bir çok yapıda kullanılan dekoratif, montajı kolay ve aynı zamanda ağır yüklere dayanıklı dilatasyon profili. Düz üst yüzey ve dekoratif görünüş dolayısıyla granit, mermer ve PVC zemin kaplamaları ile kullanımı da oldukça yaygındır. Profil montajlı olarak sevk edilir. This joint can be used various buildings such as industrial structures, hospitals and parking area. It is decorative, easily installed as well as resistant to high loads.

### TEKNİK ÖZELLİKLER / TECHNICAL FEATURES

Açıklık : 50-200 mm aralığında  
Width: between 50-200 mm  
Yükseklik : 14-28-43-60 mm  
Height: 14-28-43-60 mm  
3 ton araç, 1,5 ton forklift yüküne dayanıklı. Bu yük dayanımı dilatasyon açıklığı 100mm için geçerlidir.  
Resistant 3 tones vehicle load, 1,5 tones forklift load. This load resistant is acceptable for 100mm gap.  
Haraket Kapasitesi:  $\pm 14$ mm  
Movement Capacity:  $\pm 14$ mm

## AR823-101 H:50

### AÇIKLAMA / EXPLANATION

Alışveriş merkezleri, hastaneler, genel amaçlı kamu binaları ve iş merkezleri için uygun yoğun yaya ve hafif araç trafiğine dayanıklı düz üst yüzeyli dekoratif dilatasyon profilidir. AR823-101 is used for intensive pedestrian and light vehicle traffic areas such as shopping malls, hospitals and residential buildings. It's advantages are decorative surface and easy application.

### TEKNİK ÖZELLİKLER / TECHNICAL FEATURES

Açıklık : 100mm  
Width: 100 mm  
Yükseklik : 30-50-70-90 mm  
Height: 30-50-70-90 mm  
6 ton araç 2,5 ton forklift yüküne dayanıklı  
Resistant to 6 tones vehicle traffic and 2,5 tones forklift load  
Haraket Kapasitesi:  $\pm 18$ mm  
Movement Capacity:  $\pm 18$ mm  
Profil Boyu: 4mt.  
Profile Length: 4mt

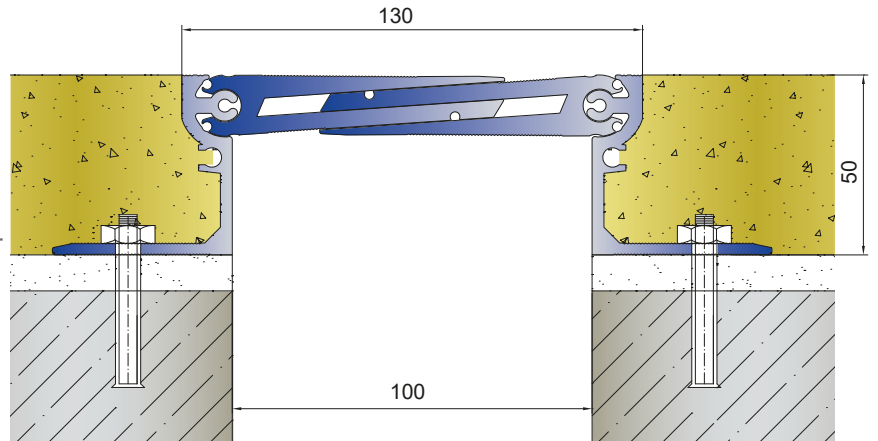



## AR723-100

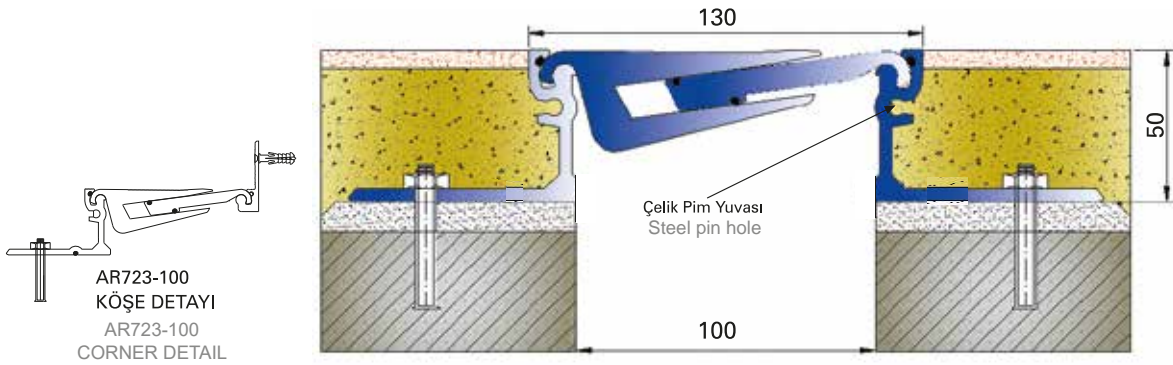

Farklı ayak yükseklikleri ile her türlü zeminde kullanılabilme imkanı  
It can be used for all kinds of floor with various foot height

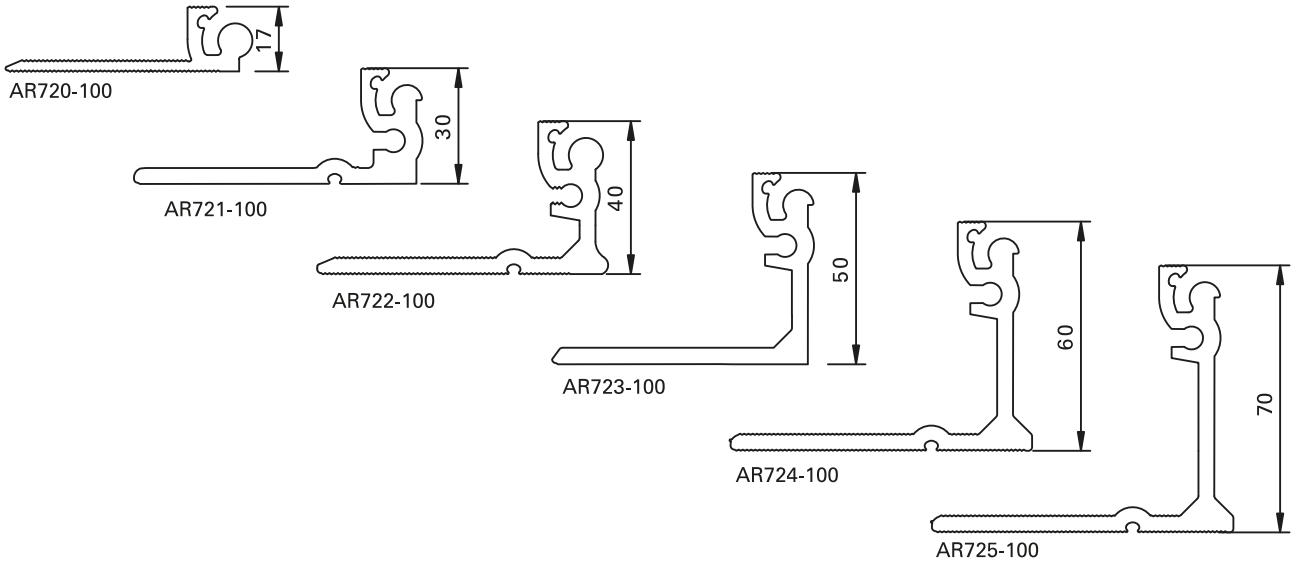

### AÇIKLAMA / EXPLANATION

Endüstriyel yapılarda forklift trafiğine dayanıklı olduğu için, hastane ve alışveriş merkezi gibi yapılarda ise düz üst yüzeyi dolayısıyla hijyenik olması ve Epdm contaları dolayısıyla da sesi izole ettiği için tercih edilir.  
AR700 serisi profiller montajlı bir şekilde sevk edilirler.  
Resistant to the forklift traffic in industrial structures and hygienic for some structures such as hospital and shopping malls and isolates the sound.  
AR700 series are delivered in assembled.

### TEKNİK ÖZELLİKLER / TECHNICAL FEATURES

Açıklık : 50-100 mm aralığında  
Width: between 50-100 mm  
Yükseklik : 17-30-40-50-60-70 mm  
Height: 17-30-40-50-60-70 mm  
30 ton araç yükü 6,5 ton forklift aks yüküne dayanıklı  
Resistant to 30 tones vehicle load and 6,5 tones forklift load.  
Haraket Kapasitesi: ± 20mm  
Movement Capacity: ± 20mm  
Profil Boyu: 4mt.  
Profile Length: 4mt.



## AR734-100

### AÇIKLAMA / EXPLANATION

Özellikle otoparklar ve otopark köprüleri için araç trafiğine dayanıklı dilatasyon profil.  
Joint profile suitable to the vehicle traffic for parking and parking bridges. It is suitable for asphalt and industrial floors.

### TEKNİK ÖZELLİKLER / TECHNICAL FEATURES

Açıklık : 100 mm  
Width: 100 mm  
Yükseklik : 60 mm  
Height: 60 mm  
30 ton araç yükü, 2,5 ton forklift yüküne dayanıklı.  
Resistant 30 tones vehicle load and 2,5 tones forklift load.  
Haraket Kapasitesi :  $\pm 15$ mm  
Movement Capacity:  $\pm 15$ mm  
Profil Boyu: 4mt.  
Profile Length: 4mt

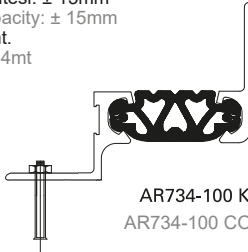

AR734-100 KÖŞE DETAYI  
AR734-100 CORNER DETAIL

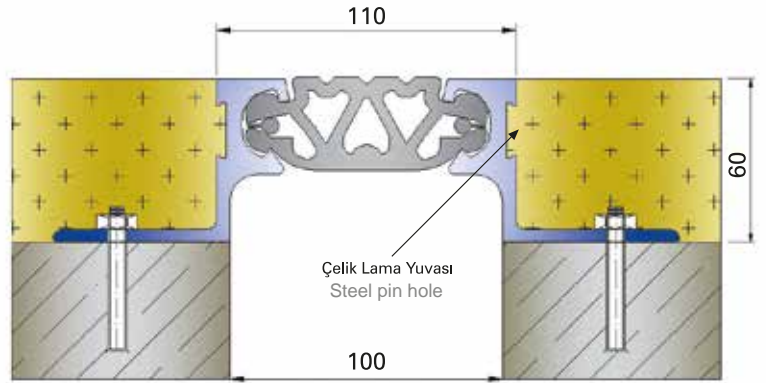

## AR823-100

### AÇIKLAMA / EXPLANATION

Endüstriyel zeminler, alışveriş merkezleri, fabrikalar, depolar gibi trafik veya yoğun yaya trafiğine maruz yerlerde kullanılır.  
Suitable for industrial floors, shopping malls, fabrics, stores which are exposed to the vehicle traffic or pedestrian traffic.

### TEKNİK ÖZELLİKLER / TECHNICAL FEATURES

Açıklık : 100 mm  
Width: 100 mm  
Yükseklik : 25-50-60-70 mm  
Height: 25-50-60-70 mm  
30 ton araç yükü, 6,5 ton forklift aks yüküne dayanıklı.  
Resistant 30 tones vehicle load and 6,5 tones forklift load.  
Haraket Kapasitesi :  $\pm 20$ mm  
Movement Capacity:  $\pm 20$ mm  
Profil Boyu: 4mt.  
Profile Length: 4mt

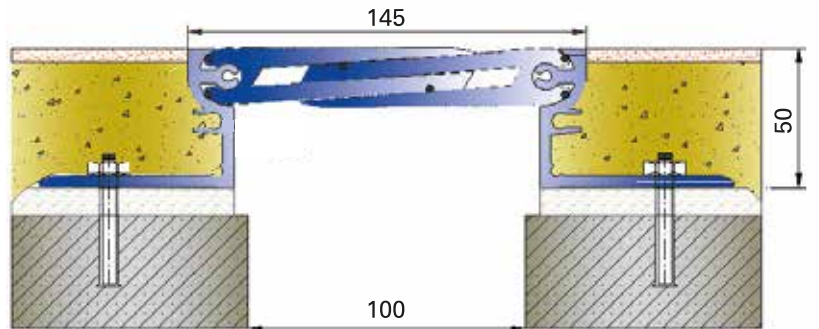





## AR801-100 SİSMİK DİLATASYON DETAYI / SEISMIC DETAILS

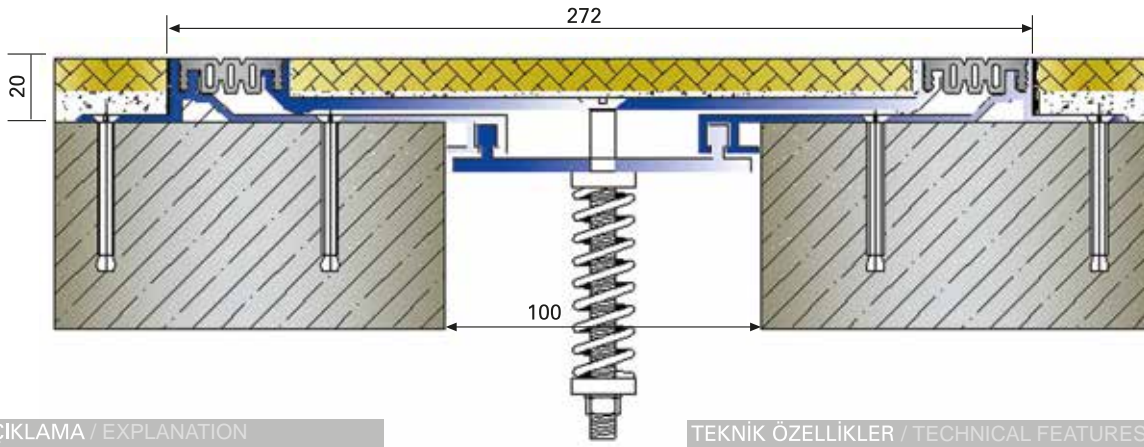

### AÇIKLAMA / EXPLANATION

10 cm açıklık için sismik kaplama altı zemin dilatasyon profili.  
Su izolasyonu, yangın bariyeri opsiyonel.  
Zeminde epoksi veya yapıştırma seramik, duvar ve tavanda ise alçıpan ve sıva kaplamalarına uygun.  
Seismic expansion joint profile for 10cm width.  
Water isolation, fire barriers are optional.  
It is suitable for drywall and coating overlay on wall and ceiling as well as epoxy or cementation ceramic on the floor.

### TEKNİK ÖZELLİKLER / TECHNICAL FEATURES

Açıklık : 100 mm  
Width: 100 mm  
Yükseklik : 20 mm  
Height: 20 mm  
Yaya trafiğine dayanıklı  
Resistant to pedestrian traffic  
Haraket Kapasitesi: ± 50mm  
Movement Capacity: ± 50mm  
Profil Boyu: 3mt.  
Profile Length: 3mt.

## AR802-100 SİSMİK DİLATASYON DETAYI / SEISMIC DETAILS

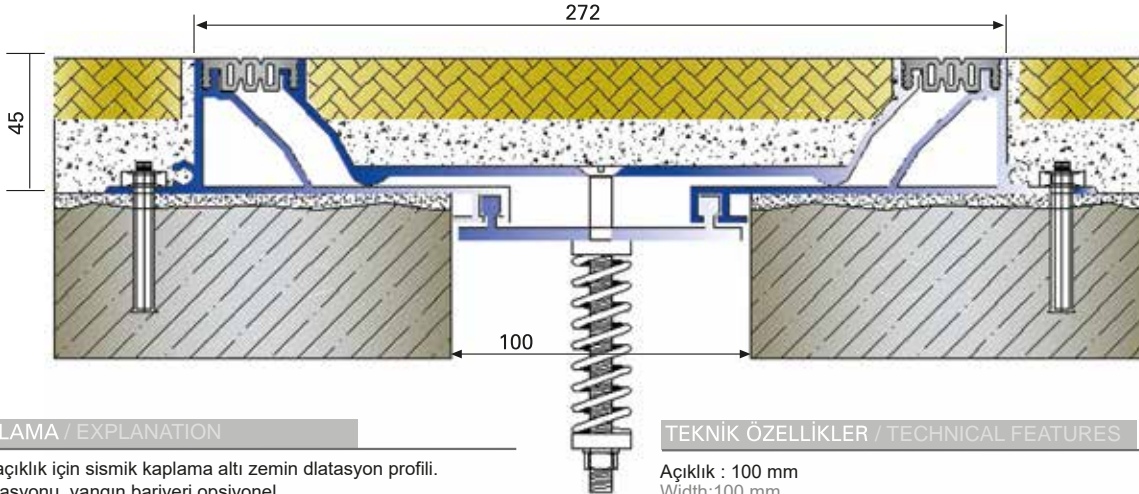

### AÇIKLAMA / EXPLANATION

10cm açıklık için sismik kaplama altı zemin dilatasyon profili.  
Su izolasyonu, yangın bariyeri opsiyonel.  
Zeminde granit, mermer ve PVC zemin kaplamalarına uygun.  
Seismic expansion joint profile for 10cm width.  
Water isolation, fire barriers are optional.  
It is suitable for granite, marble and PVC floor overlays.

### TEKNİK ÖZELLİKLER / TECHNICAL FEATURES

Açıklık : 100 mm  
Width: 100 mm  
Yükseklik : 45 mm  
Height: 45 mm  
Yaya trafiğine dayanıklı  
Resistant to pedestrian traffic  
Haraket Kapasitesi: ± 50mm  
Movement Capacity: ± 50mm  
Profil Boyu: 3mt.  
Profile Length: 3mt.





### AR814-100

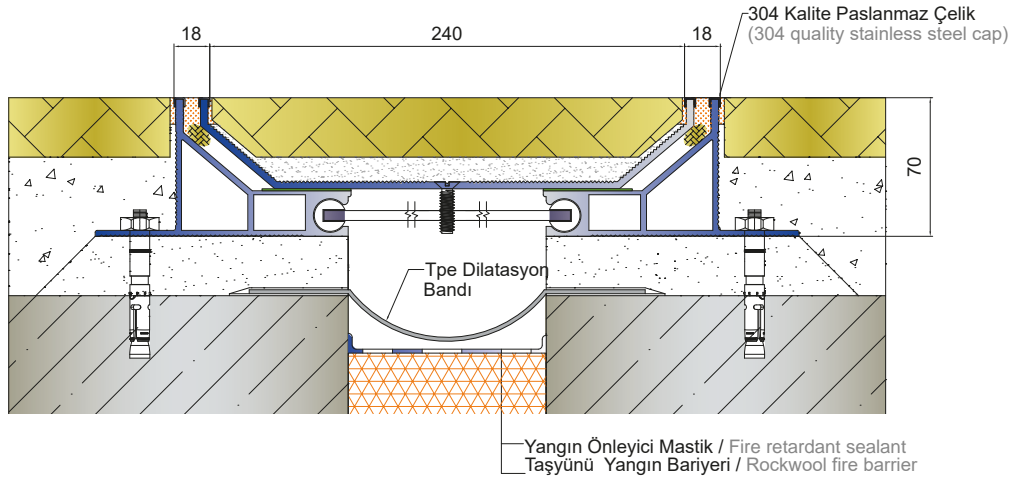

#### AÇIKLAMA / EXPLANATION

10 cm açıklık için mastik uygulamalı sismik kaplama altı zemin dilatasyon profili. Paslanmaz üst yüzey ve alüminyum yüzey alternatifli dekoratif dilatasyon profilidir. Orta sistem ile alt profil arasında ses izolasyonu sağlayan TPE yastık mevcuttur.

This seismic expansion joint profile is installed with epoxy mortar. It has stainless steel cover alternative and aluminium alternative. There is TPE sound absorber between middle profile and side leg.

#### TEKNİK ÖZELLİKLER / TECHNICAL FEATURES

Açıklık : 50-100 mm  
Width:50-100 mm  
Yükseklik : 70 mm  
Height: 70 mm  
Yaya trafiğine dayanıklı  
Resistant to pedestrian traffic  
Haraket Kapasitesi: ± 50mm  
Movement Capacity: ± 50mm  
Profil Boyu: 3mt.  
Profile Length: 3mt.

### AR814-101

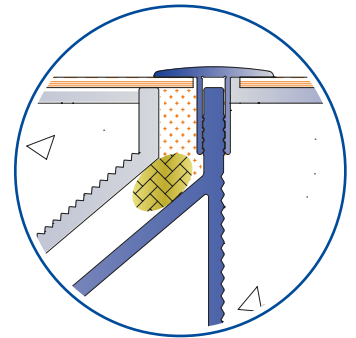
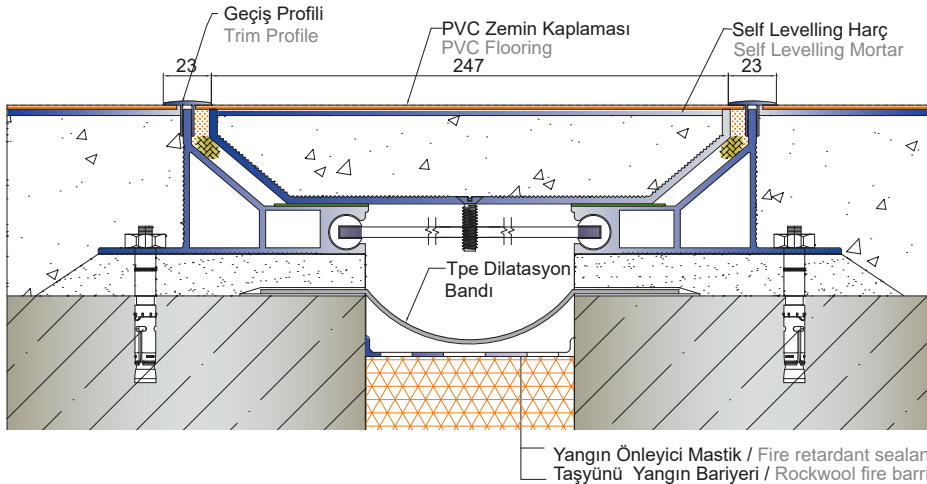

Zemin geçiş profili  
Floor trim profile

#### AÇIKLAMA / EXPLANATION

10 cm açıklık için mastik uygulamalı sismik kaplama altı zemin dilatasyon profili. PVC, halı ve farklı bir çok zemin kaplamasında alüminyum üst görünümlü dilatasyon profilidir. Orta sistem ile alt profil arasında ses izolasyonu sağlayan TPE yastık mevcuttur.

This seismic expansion joint profile is installed with epoxy mortar. It has a trim profile which can cover many type of floor materials such as PVC flooring, carpet etc. There is TPE sound absorber between middle profile and side leg.

#### TEKNİK ÖZELLİKLER / TECHNICAL FEATURES

Açıklık : 50-100 mm  
Width:50-100 mm  
Yükseklik : 70 mm  
Height: 70 mm  
Yaya trafiğine dayanıklı  
Resistant to pedestrian traffic  
Haraket Kapasitesi: ± 50mm  
Movement Capacity: ± 50mm  
Profil Boyu: 3mt.  
Profile Length: 3mt.



## AR51-050

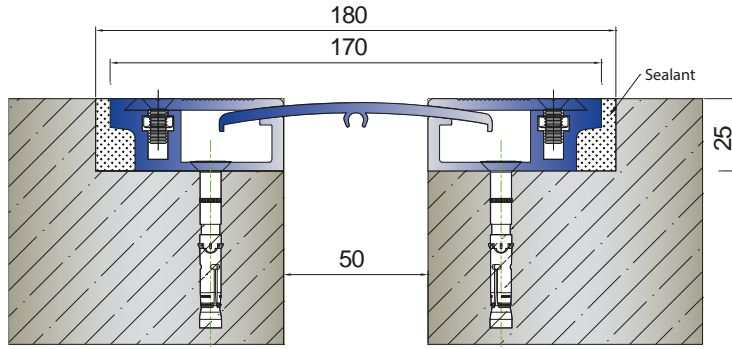

### AÇIKLAMA / EXPLANATION

Yüksek hareket kapasitesi istenen yerlerde yaya ve araç trafiğine dayanıklı dilatasyon profili.  
Epdm buhar bariyeri opsiyonel.  
Joint profile resistant to the pedestrian and vehicle traffic in high movement capacity.  
Vapour barrier is optional.

### TEKNİK ÖZELLİKLER / TECHNICAL FEATURES

Açıklık : 50 mm  
Width: 50 mm  
Yükseklik : 25 mm  
Height: 25 mm  
2,7 ton araç trafiğine dayanıklı  
Resistant to 2,7 tones of the vehicle traffic  
Haraket Kapasitesi: ± 25mm  
Movement Capacity: ± 25mm  
Profil Boyu: 3mt.  
Profile Length: 3mt

## AR51-100

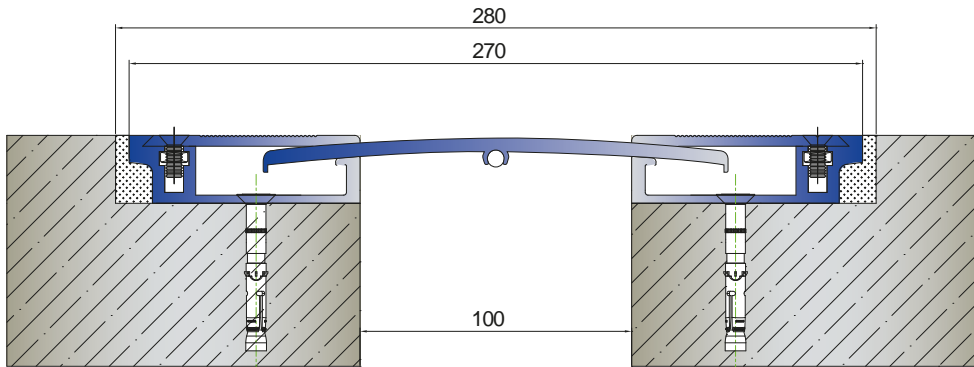

### AÇIKLAMA / EXPLANATION

Yüksek hareket kapasitesi istenen yerlerde yaya ve araç trafiğine dayanıklı dilatasyon profili.  
Epdm buhar bariyeri opsiyonel.  
Joint profile resistant to the pedestrian and vehicle traffic in high movement capacity.  
Vapour barrier is optional.

### TEKNİK ÖZELLİKLER / TECHNICAL FEATURES

Açıklık : 100 mm  
Width: 100 mm  
Yükseklik : 25 mm  
Height: 25 mm  
2,5 ton araç trafiğine dayanıklı  
Resistant to 2,5 tones of the vehicle traffic  
Haraket Kapasitesi: ± 50mm  
Movement Capacity: ± 50mm  
Profil Boyu: 3mt.  
Profile Length: 3mt



## AR813-100

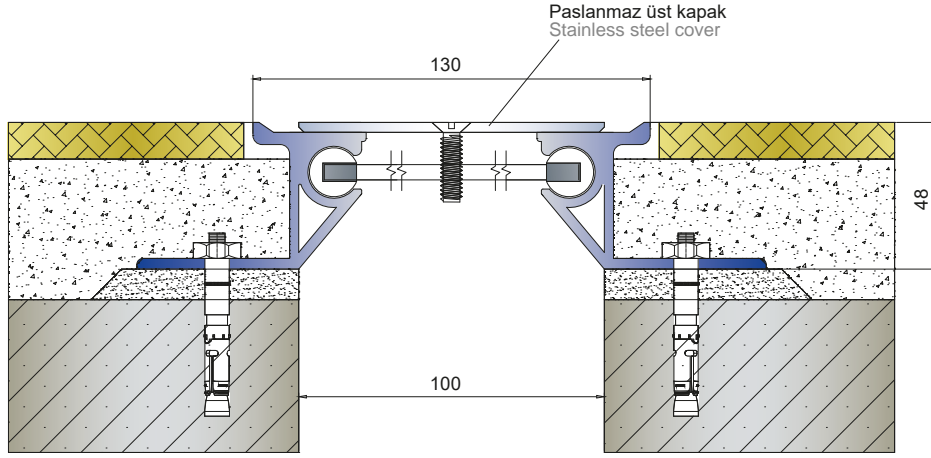

## AÇIKLAMA / EXPLANATION

Yüksek hareket kapasitesi, aşınma dayanımı ve kimyasallara dayanım istenen alanlarda (alışveriş merkezleri, metro istasyonları, gıda ve ilaç tesisleri) kullanılan paslanmaz üst yüzeyli kaplama altı zemin dilatasyon profilidir. Epdm buhar bariyeri opsiyonel.

Stainless steel top covered profile is used for many places where high movement capacity and abrasive strength and chemical strength is necessary. Epdm vapour barrier is optional.

## TEKNİK ÖZELLİKLER / TECHNICAL FEATURES

Açıklık : 100 mm  
Width: 100 mm  
Yükseklik : 48 mm  
Height: 48 mm  
3 ton araç trafiğine dayanıklı  
Resistant to 3 tones of the vehicle traffic  
Haraket Kapasitesi :  $\pm 50$ mm  
Movement Capacity:  $\pm 50$ mm  
Profil Boyu: 3mt.  
Profile Length: 3mt



## AR951-100

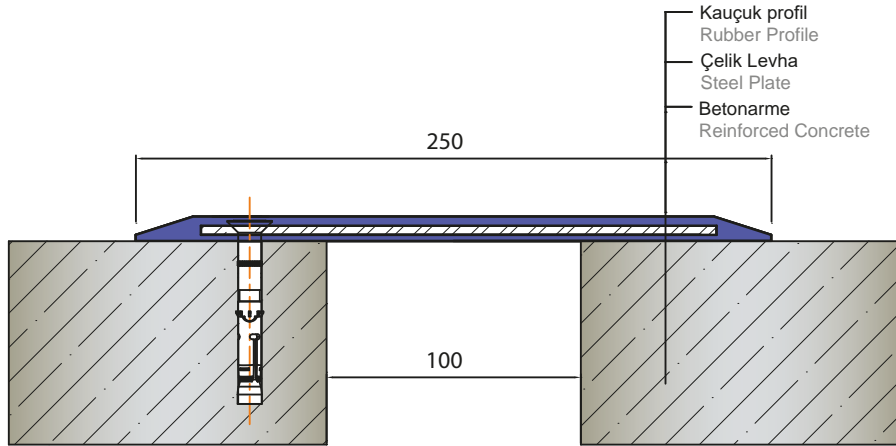

## AÇIKLAMA / EXPLANATION

Otopark dilatasyonlarında kullanılan, ST37 çelik ve kauçuktan mamul, zemin dilatasyon profili.

Used in park dilatation, made of ST37 steel and rubber, floor profile.

## TEKNİK ÖZELLİKLER / TECHNICAL FEATURES

Açıklık : 100 mm  
Width: 100 mm  
Yükseklik : 8 mm  
Height: 8 mm  
16 ton araç, 3.5 ton forklift yüküne dayanıklı  
16 tonne vehicles 3.5 ton forklift capacity  
Profil Boyu: 2mt.  
Profile Length: 2mt



## AR153-100

### AÇIKLAMA / EXPLANATION

Granit, seramik, vinil, endüstriyel zemin v.b. kaplamalara uygun montaj delikleri açılmış eloksalli zemin dilatasyon profili.

Anodised joint profiles with screw holes.  
Suitable for some overlays such as granite, ceramic, vinyl, industrial floor etc.

### TEKNİK ÖZELLİKLER / TECHNICAL FEATURES

Açıklık : 100 mm  
Width: 100 mm  
Derinlik : 30 mm  
Depth: 30 mm  
Yaya trafiğine dayanıklı  
Resistant to pedestrian traffic  
Haraket Kapasitesi:  $\pm 16$ mm  
Movement Capacity:  $\pm 16$ mm  
Profil Boyu: 3mt.  
Profile Length: 3mt.

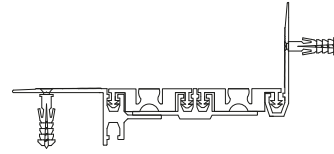
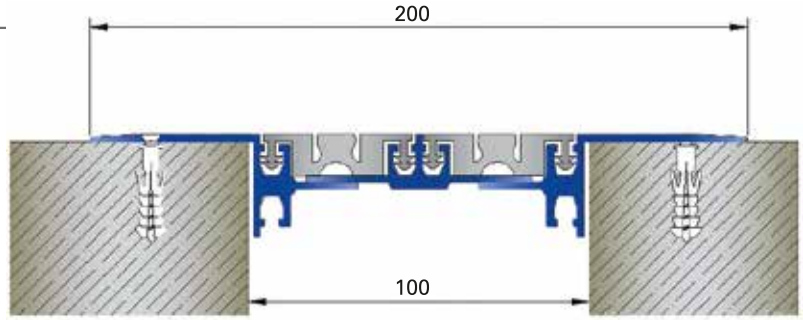

AR153-100 KÖŞE DETAYI  
AR153-100 CORNER DETAIL

## AR174-100

### AÇIKLAMA / EXPLANATION

Kaplama üzeri montaj delikleri açılmış zemin dilatasyon profili. Profil montajlı olarak sevk edilir.

Joint profile has some screw holes for fixing on the overlay. It is delivered in assembled.

### TEKNİK ÖZELLİKLER / TECHNICAL FEATURES

Açıklık : 100 mm  
Width: 100 mm  
Derinlik : 26 mm  
Depth: 26 mm  
Yaya trafiğine dayanıklı  
Resistant to pedestrian traffic  
Haraket Kapasitesi:  $\pm 14$ mm  
Movement Capacity:  $\pm 14$ mm  
Profil Boyu: 3mt.  
Profile Length: 3mt.

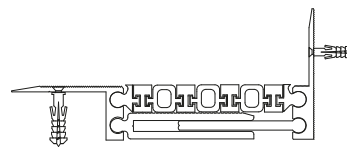
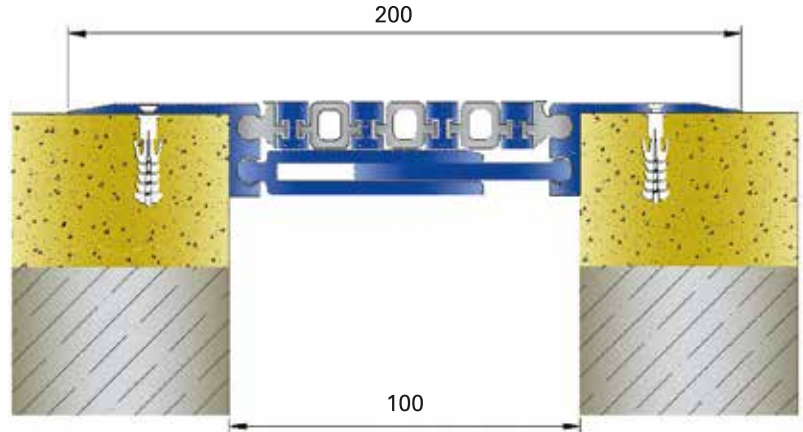

AR174-100 KÖŞE DETAYI  
AR174-100 CORNER DETAIL



### AR883-100

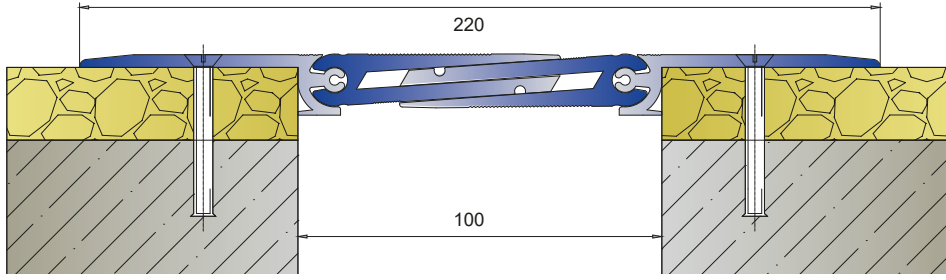

#### AÇIKLAMA / EXPLANATION

Kaplama üstü düz yüzeyli zemin dilatasyon profili. Profil montajlı ve vida delikleri açılmış olarak sevk edilir. A floor dilatation profile which has smooth surface on the overlay. It is delivered in assembled with screw holes.

#### TEKNİK ÖZELLİKLER / TECHNICAL FEATURES

Açıklık : 100 mm  
Width: 100 mm  
Derinlik : 14 mm  
Depth: 14 mm  
6 ton araç yükü 1,5 ton forklift yüküne dayanıklı  
Resistant to 6 tones the vehicle load and 1,5 tones the forklift load.  
Haraket Kapasitesi : ± 12mm  
Movement Capacity: ± 12mm  
Profil Boyu: 4mt.  
Profile Length: 4mt

### AR773-100

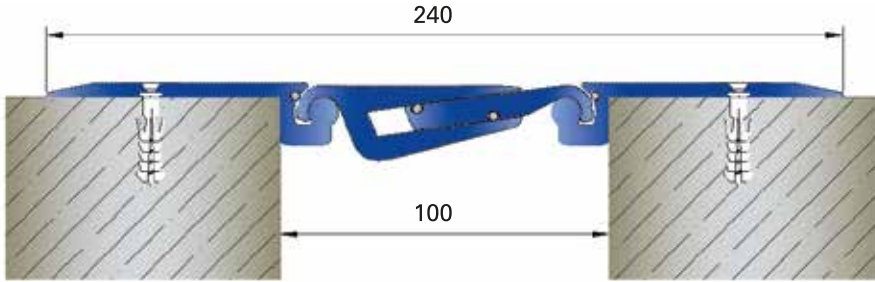

AR773-100 KÖŞE DETAYI  
AR773-100 CORNER DETAIL

#### AÇIKLAMA / EXPLANATION

Kaplama üstü düz yüzeyli zemin dilatasyon profili. Profil montajlı ve vida delikleri açılmış olarak sevk edilir. A floor dilatation profile which has smooth surface on the overlay. It is delivered in assembled with screw holes.

#### TEKNİK ÖZELLİKLER / TECHNICAL FEATURES

Açıklık : 100 mm  
Width: 100 mm  
Derinlik : 20 mm  
Depth: 20 mm  
6 ton araç yükü 1,5 ton forklift yüküne dayanıklı  
Resistant to 6 ton of the vehicle load and 1,5 ton of the forklift load.  
Haraket Kapasitesi : ± 12mm  
Movement Capacity: ± 12mm  
Profil Boyu: 4mt.  
Profile Length: 4mt

### AR191-100

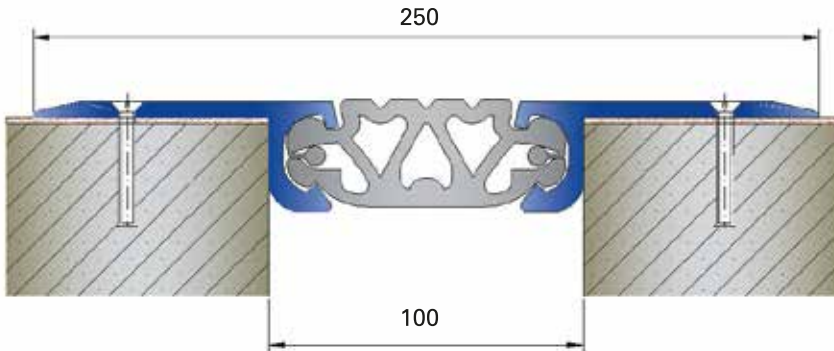

AR191-100 KÖŞE DETAYI  
AR191-100 CORNER DETAIL

#### AÇIKLAMA / EXPLANATION

Özellikle otoparklar için ağır yüklere dayanıklı zemin dilatasyon profili. Joint profile resistant to high loads for the parking areas.

#### TEKNİK ÖZELLİKLER / TECHNICAL FEATURES

Açıklık : 100 mm  
Width: 100 mm  
Derinlik : 30 mm  
Depth: 30 mm  
30 ton araç trafiğine dayanıklı  
Resistant to 30 tonnes of the vehicle traffic.  
Haraket Kapasitesi : ± 15mm  
Movement Capacity: ± 15mm  
Profil Boyu: 4mt.  
Profile Length: 4mt



AR911-100

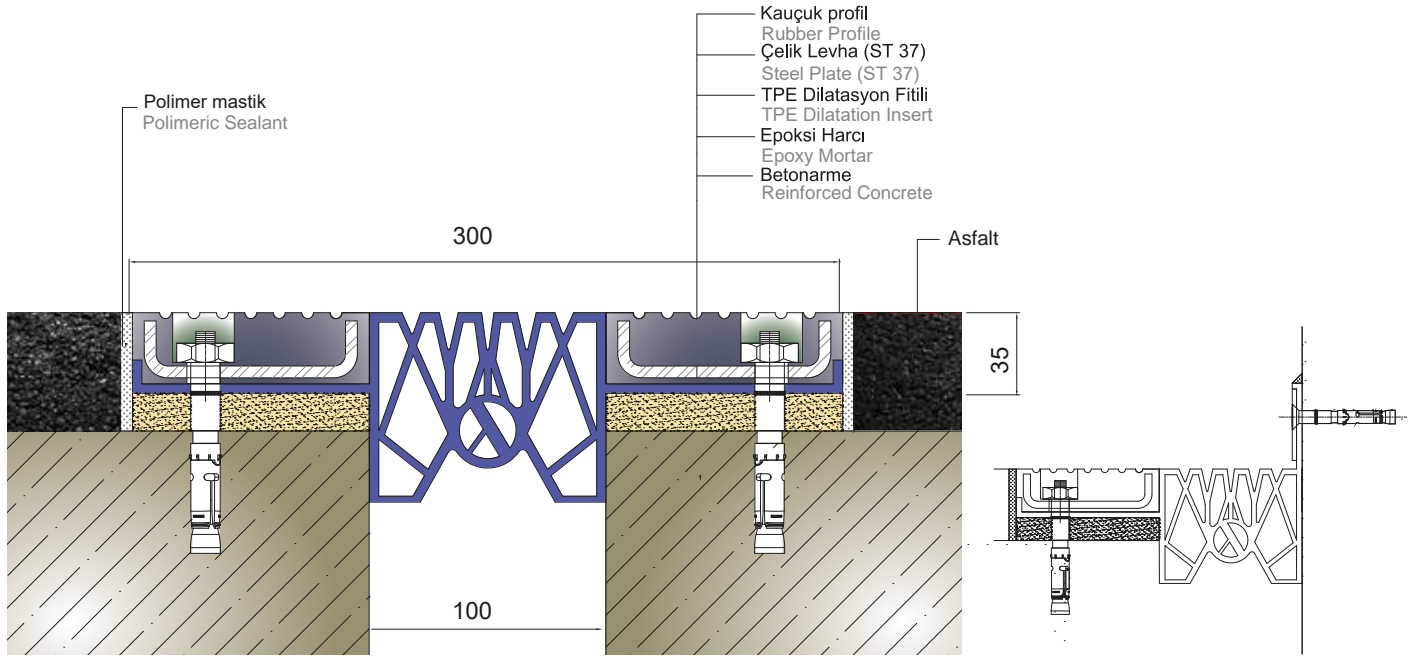

AÇIKLAMA / EXPLANATION

Köprü dilatasyonları, bina yaklaşım köprüleri, otopark dilatasyonlarında kullanılan, ST37 çelik ve kauçuktan mamul kompozit dilatasyon profili. This composite profile is used for especially car parks, and bridges which is located on roadways or shopping malls (It is not suitable for highway roads)

TEKNİK ÖZELLİKLER / TECHNICAL FEATURES

Açıklık : 100 mm  
Width: 100 mm  
Yükseklik : 35 mm  
Height: 35 mm  
AASHTO HS20'ye göre 14,5 ton araç aks yüküne dayanıklı.  
Resistant to 14,5 tones vehicle axle traffic according to AASHTO.  
Hareket Kapasitesi: ± 50mm  
Movement Capacity: ± 50mm  
Profil Boyu: 2mt.  
Profile Length: 2mt  
Fıtıl Boyu: 16mt.  
Fıtıl Length: 16mt

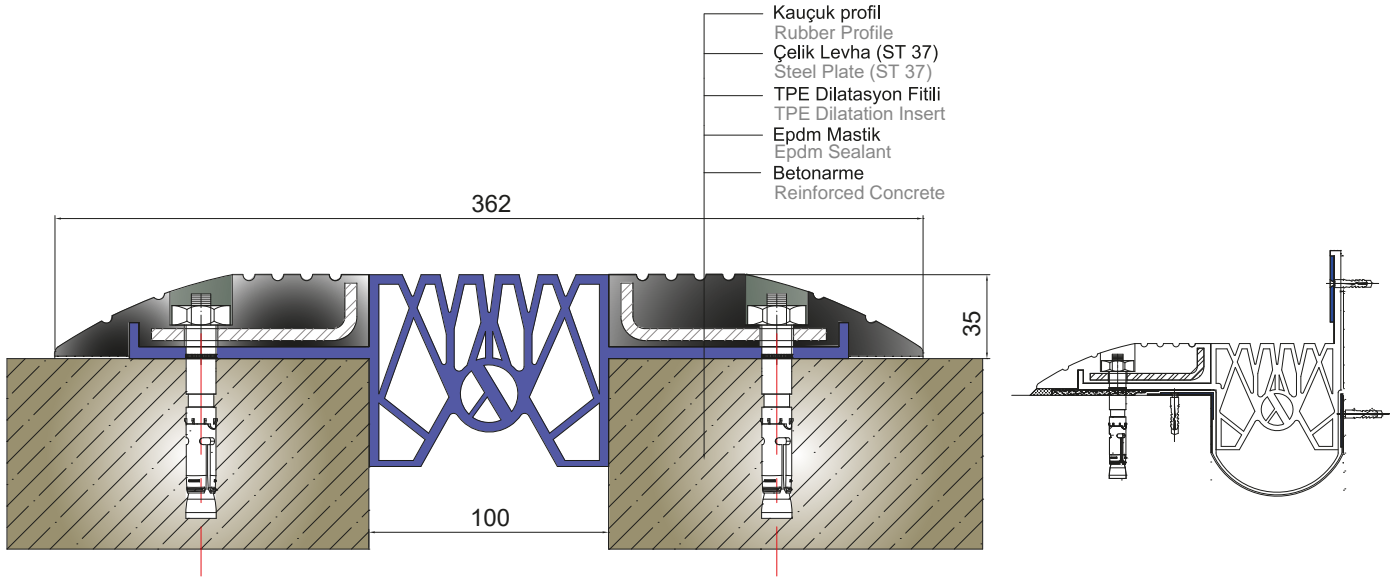

**AR921-100**

**AÇIKLAMA / EXPLANATION**

Otopark dilatasyonlarında kullanılan, ST37 çelik ve kauçuktan mamul, kasis özellikli, rampa tipi kompozit dilatasyon profili.

This special composite profile is made of from high quality rubber and steel sheet. Especially it is suitable for carpark area where there isn't any finishing material. It is also best solution for repairing on exist carparks.

**TEKNİK ÖZELLİKLER / TECHNICAL FEATURES**

**Açıklık : 100 mm**

Width: 100 mm

**Yükseklik : 35 mm**

Height: 35 mm

**6,5 ton araç aks yüküne dayanıklı. Kaymaya karşı yüzeyi çizgili.**

Resistant to 6,5 axle load. It has also line over the profile for anti slip.

**Hareket Kapasitesi: ± 50mm**

Movement Capacity: ± 50mm

**Profil Boyu: 2mt.**

Profile Length: 2mt

**Fitil Boyu: 16mt.**

Fitil Length: 16mt

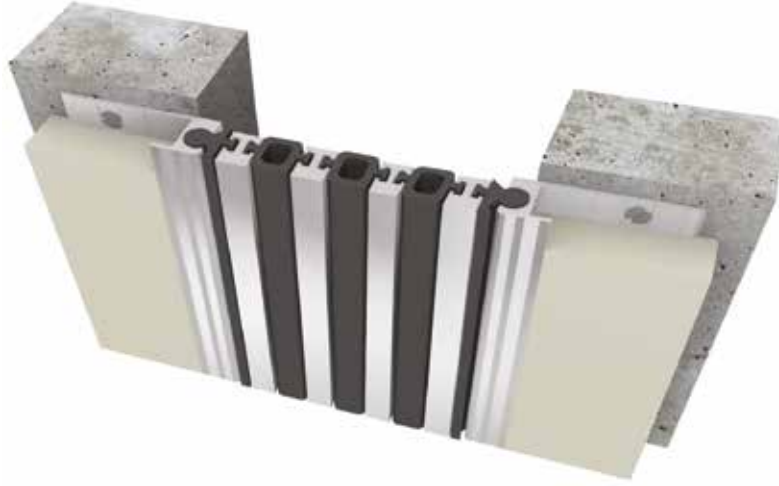

## AR202-100

### AÇIKLAMA / EXPLANATION

Sıva ve alçıpan altı duvar tavan dilatasyon profili.  
A wall and ceiling joint profile for under plaster.  
Suitable for drywall and plaster.

### TEKNİK ÖZELLİKLER / TECHNICAL FEATURES

Açıklık : 100 mm  
Width: 100 mm  
Yükseklik : 15 mm  
Height: 15 mm  
Haraket Kapasitesi:  $\pm 50$ mm  
Movement Capacity:  $\pm 50$ mm  
Profil Boyu: 3mt.  
Profile Length: 3mt

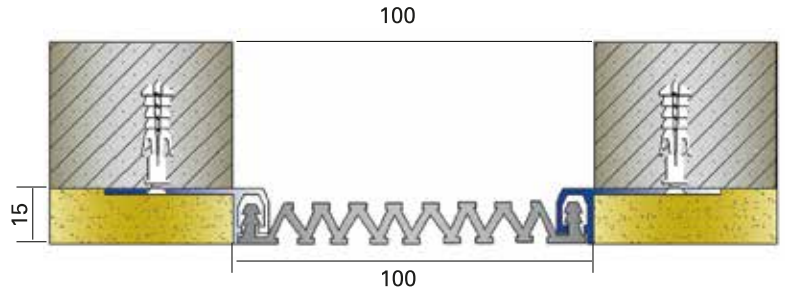
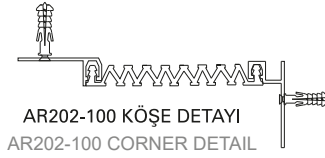

## AR211-100

### AÇIKLAMA / EXPLANATION

Sıva ve alçıpan altı duvar tavan dilatasyon profili.  
AR303-100 ile tam uyumlu  
A wall and ceiling joint profile for under plaster.  
Suitable for drywall and plaster.  
Compatible with AR303-100

### TEKNİK ÖZELLİKLER / TECHNICAL FEATURES

Açıklık : 100 mm  
Width: 100 mm  
Yükseklik : 17 mm  
Height: 17 mm  
Haraket Kapasitesi:  $\pm 14$ mm  
Movement Capacity:  $\pm 14$ mm

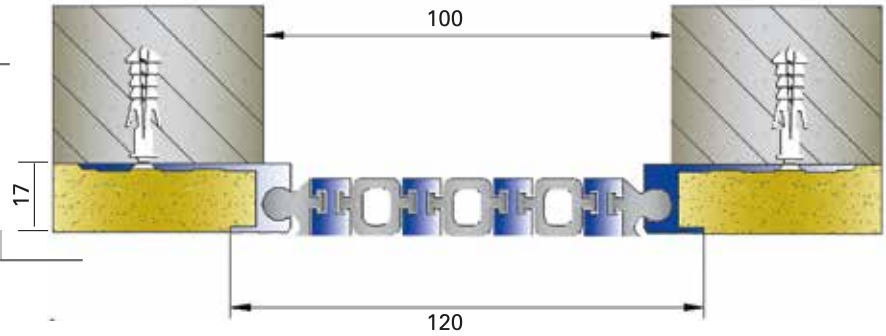
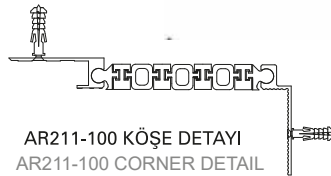

## AR202-102

### AÇIKLAMA / EXPLANATION

Sıva ve alçıpan altı duvar tavan dilatasyon profili.  
A wall and ceiling joint profile for under plaster.  
Suitable for drywall and plaster.

### TEKNİK ÖZELLİKLER / TECHNICAL FEATURES

Açıklık : 100 mm  
Width: 100 mm  
Yükseklik : 15 mm  
Height: 15 mm  
Haraket Kapasitesi:  $\pm 14$ mm  
Movement Capacity:  $\pm 14$ mm

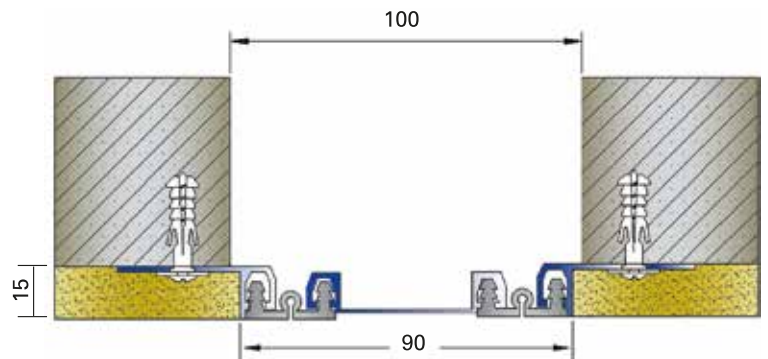
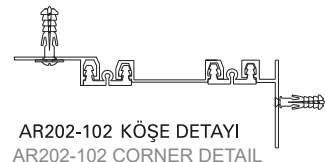



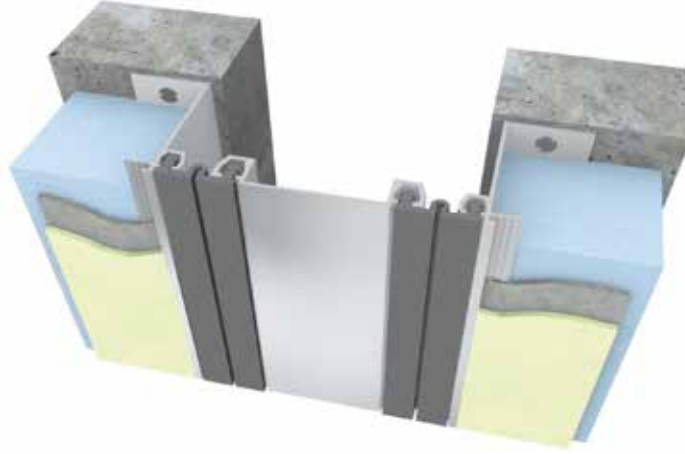

### AR202-101

#### AÇIKLAMA / EXPLANATION

Sıva altı duvar tavan dilatasyon profili.  
Wall and ceiling joint profile for under plaster.

#### TEKNİK ÖZELLİKLER / TECHNICAL FEATURES

Açıklık : 100 mm  
Width: 100 mm  
Yükseklik : 15 mm  
Height: 15 mm  
Haraket Kapasitesi:  $\pm 16$ mm  
Movement Capacity:  $\pm 16$ mm

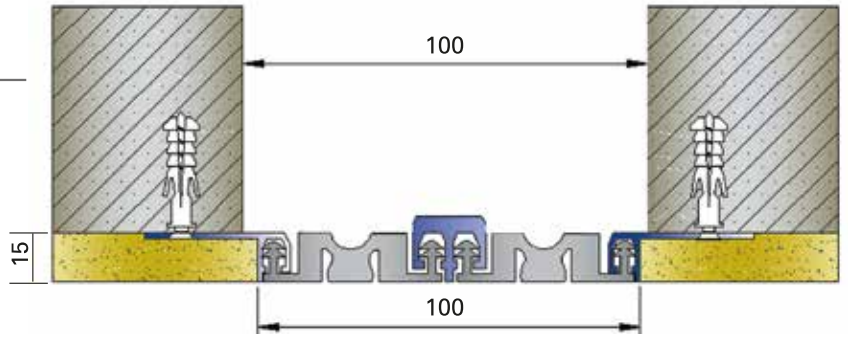
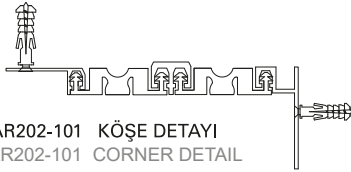

### AR221-102

#### AÇIKLAMA / EXPLANATION

Isı yalıtım altı dış cephe dilatasyon profili.  
This dilatation profile is used for on heat insulated facade

#### TEKNİK ÖZELLİKLER / TECHNICAL FEATURES

Açıklık : 100 mm  
Width: 100 mm  
Yükseklik : 55 mm  
Height: 55 mm  
Haraket Kapasitesi:  $\pm 16$ mm  
Movement Capacity:  $\pm 16$ mm

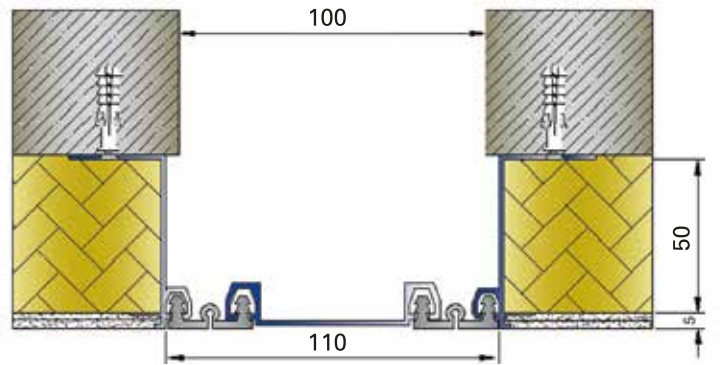
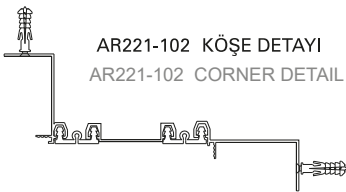

### AR221-101

#### AÇIKLAMA / EXPLANATION

Isı yalıtım altı dış cephe dilatasyon profili.  
This dilatation profile is used for on heat insulated facade

#### TEKNİK ÖZELLİKLER / TECHNICAL FEATURES

Açıklık : 100 mm  
Width: 100 mm  
Yükseklik : 55 mm  
Height: 55 mm  
Haraket Kapasitesi:  $\pm 16$ mm  
Movement Capacity:  $\pm 16$ mm

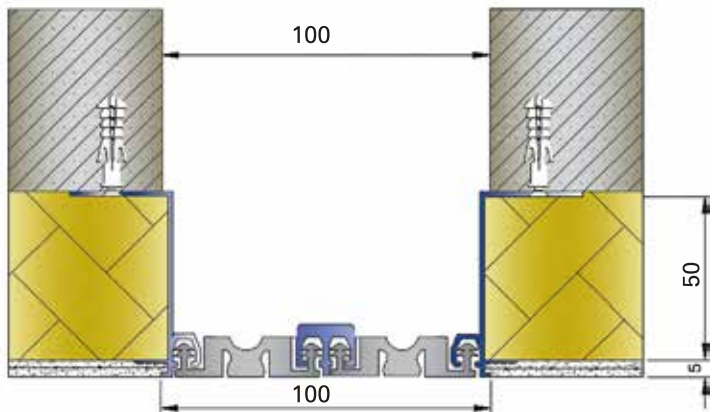
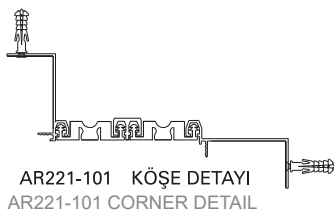



## AR252-100

### AÇIKLAMA / EXPLANATION

Eloksalli, sıva üstü duvar tavan dilatasyon profili.  
Geniş yan profilleri dolayısıyla pahlı kolonlarda da kullanılabilir.

Anodised joint profile for over finishing.  
It is used for columns and walls with it's wide side.

### TEKNİK ÖZELLİKLER / TECHNICAL FEATURES

Açıklık : 100 mm  
Width: 100 mm  
Derinlik : 15 mm  
Depth: 15 mm  
Haraket Kapasitesi:  $\pm 50$ mm  
Movement Capacity:  $\pm 50$ mm  
Profil Boyu: 3mt.  
Profile Length: 3mt

AR252-100 KÖŞE DETAYI  
AR252-100 CORNER DETAIL

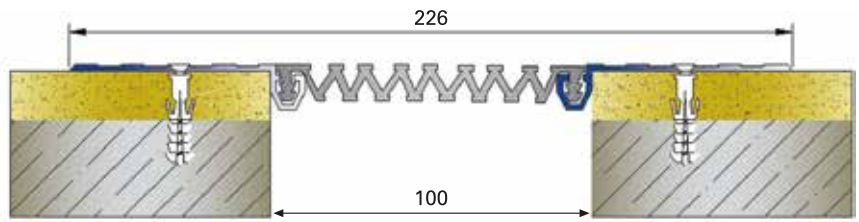

## AR259-100

### AÇIKLAMA / EXPLANATION

Sıva üstü duvar tavan dilatasyon profili.  
Profil vida delikli ve montajlı olarak sevk edilir.  
Wall and ceiling profile joint with screw holes.  
Delivered in assembled.

### TEKNİK ÖZELLİKLER / TECHNICAL FEATURES

Açıklık : 100 mm  
Width: 100 mm  
Derinlik : 15 mm  
Depth: 15 mm  
Haraket Kapasitesi:  $\pm 14$ mm  
Movement Capacity:  $\pm 14$ mm  
Profil Boyu: 3mt.  
Profile Length: 3mt  
AR303-100 serisi ve AR174-100 serisi ile tam uyumlu  
Compatible with AR303-100 series and AR174-100 series

AR259-100 KÖŞE DETAYI  
AR259-100 CORNER DETAIL

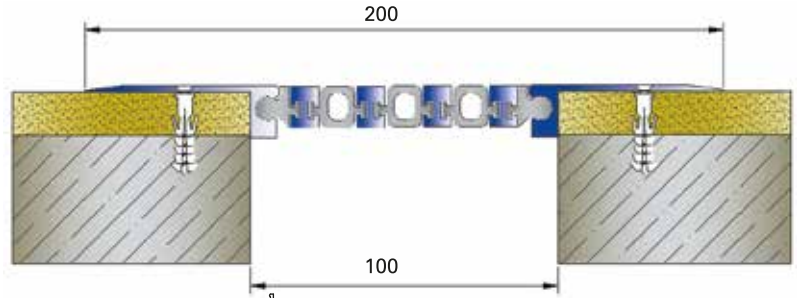
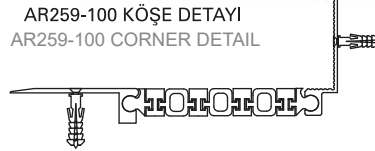

## AR261-100

### AÇIKLAMA / EXPLANATION

Eloksalli, sıva üstü, vida delikli duvar tavan dilatasyon profili.  
Anodised joint profile with screw holes

### TEKNİK ÖZELLİKLER / TECHNICAL FEATURES

Açıklık : 100 mm  
Width: 100 mm  
Derinlik : 15 mm  
Depth: 15 mm  
Haraket Kapasitesi:  $\pm 50$ mm  
Movement Capacity:  $\pm 50$ mm  
Profil Boyu: 3mt.  
Profile Length: 3mt  
Profil Et Kalınlığı: 2mm  
Profile Thickness: 2mm  
AR153-100 ve AR106-100 ile tam uyumlu  
Compatible with AR153-100 series and AR106-100 series

AR261-100 KÖŞE DETAYI  
AR261-100 CORNER DETAIL

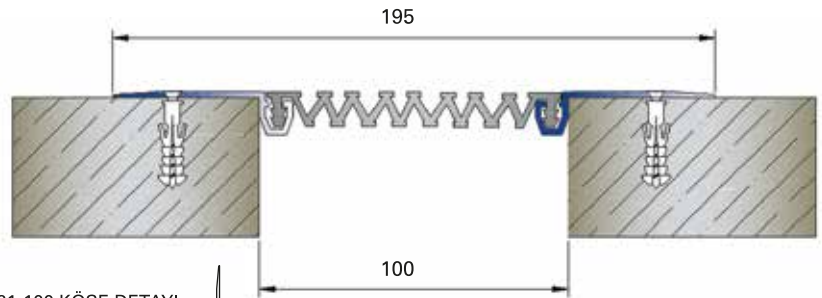
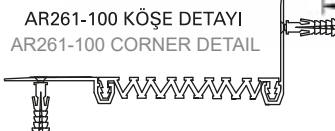



### AR262-100

#### AÇIKLAMA / EXPLANATION

Eloksalli, sıva üstü, vida delikli duvar tavan dilatasyon profili.  
Anodised joint profiles for over finishing with screw holes.

#### TEKNİK ÖZELLİKLER / TECHNICAL FEATURES

Açıklık : 100 mm  
Width: 100 mm  
Derinlik : 15 mm  
Depth: 15 mm  
Haraket Kapasitesi:  $\pm 50$ mm  
Movement Capacity:  $\pm 50$ mm  
AR153-100 ve AR106-100 ile tam uyumlu.  
Compatible with AR153-100 series and AR-106-100  
Profil Boyu: 3mt.  
Profile Length: 3mt.

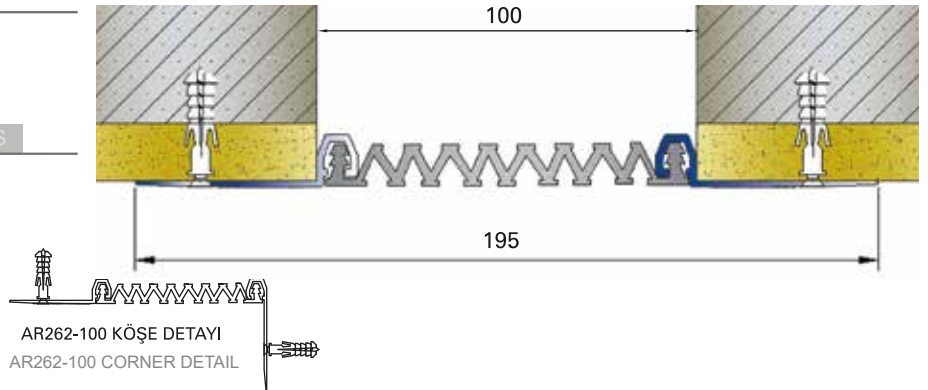

### AR262-101

#### AÇIKLAMA / EXPLANATION

Eloksalli, sıva üstü, vida delikli duvar tavan dilatasyon profili.  
Anodised joint profiles for over finishing with screw holes.

#### TEKNİK ÖZELLİKLER / TECHNICAL FEATURES

Açıklık : 100 mm  
Width: 100 mm  
Derinlik : 15 mm  
Depth: 15 mm  
Haraket Kapasitesi:  $\pm 16$ mm  
Movement Capacity:  $\pm 16$ mm  
AR153-100 ve AR106-100 ile tam uyumlu.  
Compatible with AR153-100 series and AR-106-100  
Profil Boyu: 3mt.  
Profile Length: 3mt.

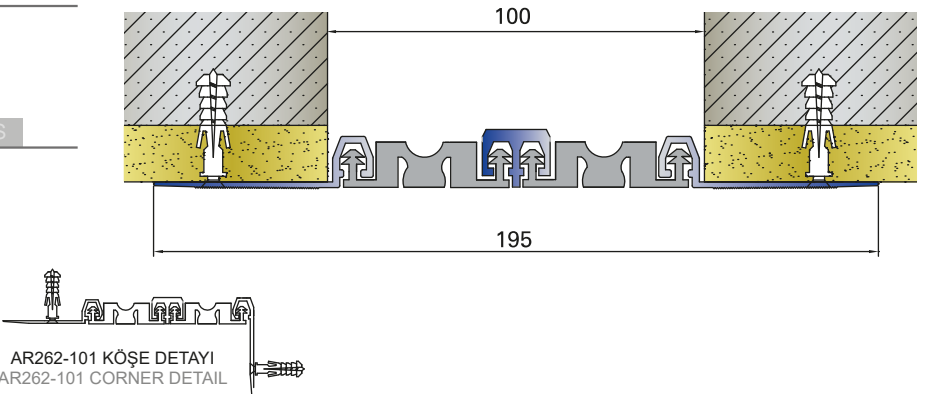

### AR262-102

#### AÇIKLAMA / EXPLANATION

Eloksalli, sıva üstü, vida delikli duvar tavan dilatasyon profili.  
Anodised joint profiles for over finishing with screw holes.

#### TEKNİK ÖZELLİKLER / TECHNICAL FEATURES

Açıklık : 100 mm  
Width: 100 mm  
Derinlik : 15 mm  
Depth: 15 mm  
Haraket Kapasitesi:  $\pm 14$ mm  
Movement Capacity:  $\pm 14$ mm  
Profil Boyu: 3mt.  
Profile Length: 3mt.

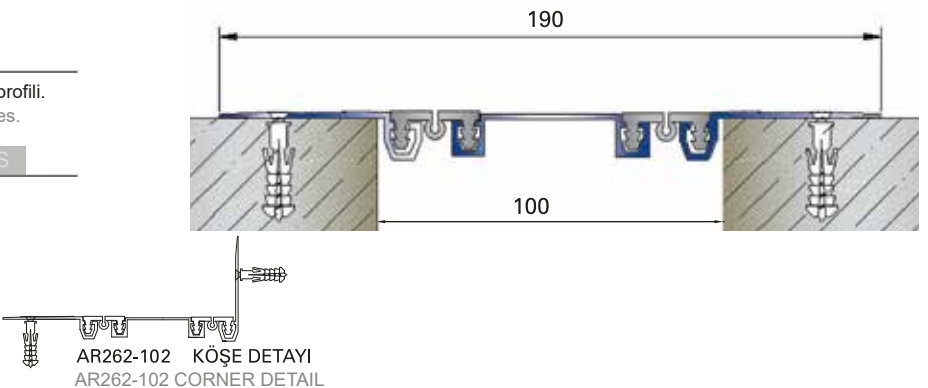



## AR281-100

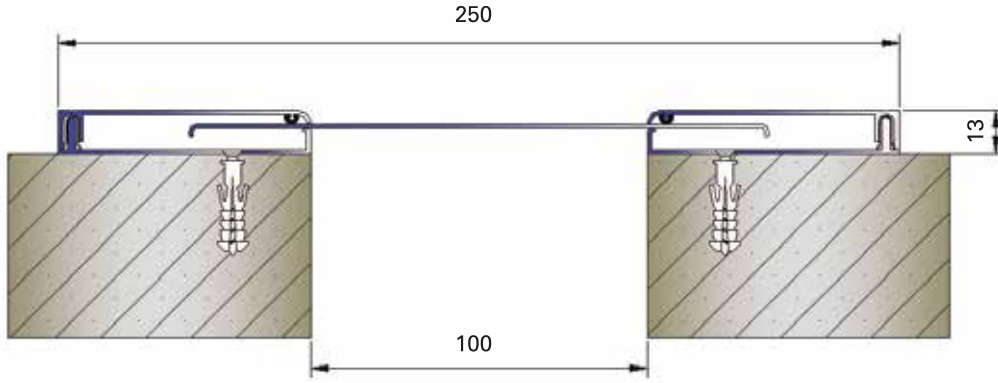

### AÇIKLAMA / EXPLANATION

Sismik duvar tavan dilatasyon profili.  
50cm ara ile kullanılan çelik yaylara üst kapak bastırılarak takılır.  
Seismic wall and ceiling joint profile.  
Top cover is fixed with steel springs.

### TEKNİK ÖZELLİKLER / TECHNICAL FEATURES

Açıklık : 100 mm  
Width: 100 mm  
Yükseklik : 13 mm  
Height: 13 mm  
Haraket Kapasitesi:  $\pm 60$ mm  
Movement Capacity:  $\pm 60$ mm



## AR281-100 K

### AÇIKLAMA / EXPLANATION

Sismik duvar tavan köşe dilatasyon profili.  
50 cm ara ile kullanılan çelik yaylara üst kapak bastırılarak takılır.

Seismic wall and ceiling joint profile.  
Top cover is fixed with steel springs.

### TEKNİK ÖZELLİKLER / TECHNICAL FEATURES

Açıklık : 100 mm  
Width: 100 mm  
Yükseklik : 13 mm  
Height: 13 mm  
Haraket Kapasitesi:  $\pm 30$ mm  
Movement Capacity:  $\pm 30$ mm  
Üst Genişlik: 175 mm  
Top Width: 175 mm

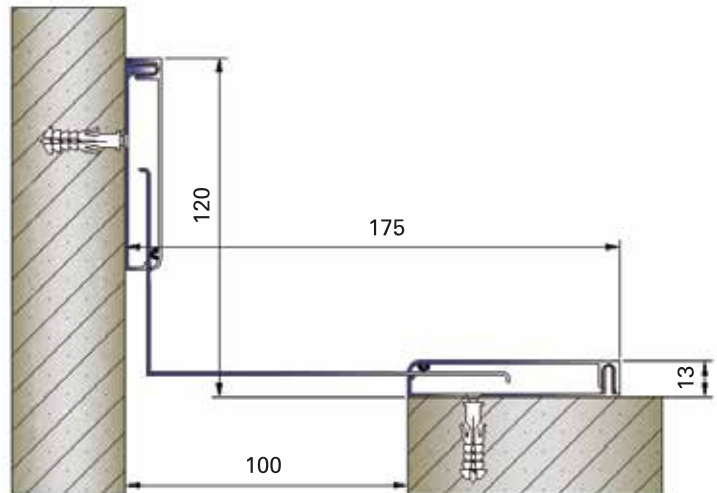



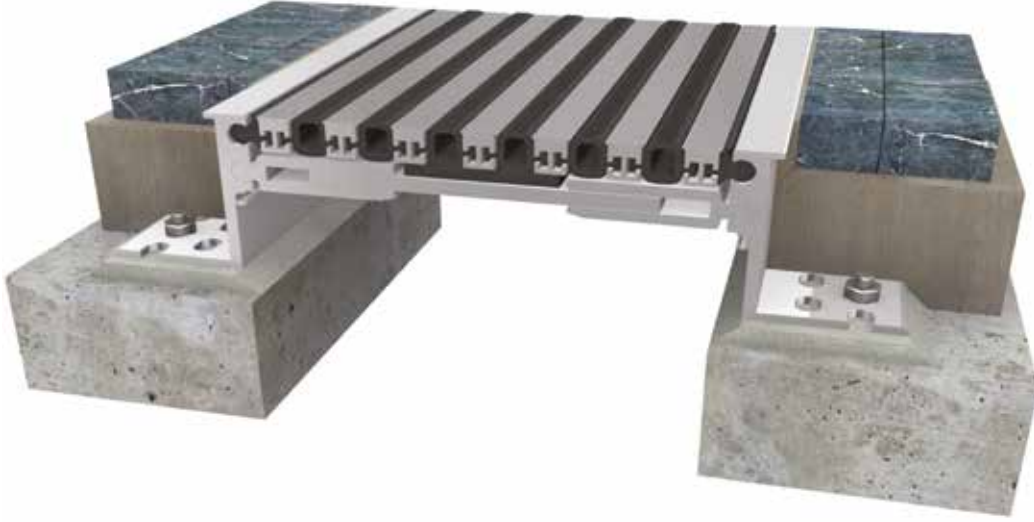

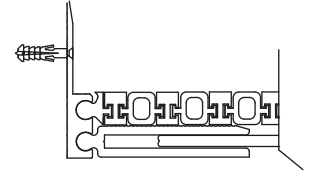
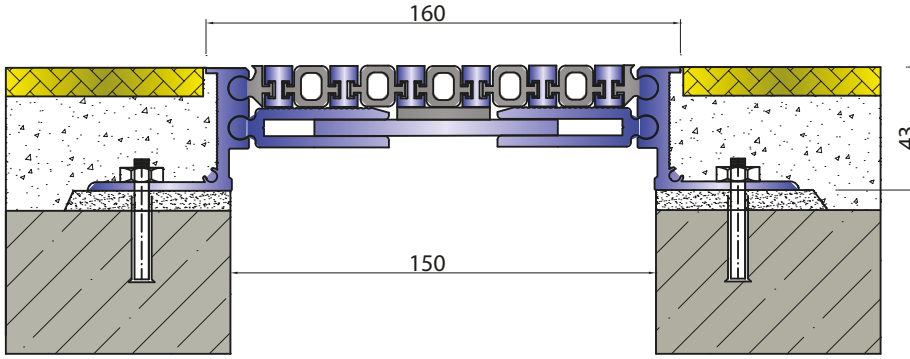
**AR303-150**

**AR303-150 KÖŞE DETAYI**  
**AR303-150 CORNER DETAIL**
**AÇIKLAMA / EXPLANATION**

15cm açıklık için kaplama altı zemin dilatasyon profili.  
 Profil montajlı olarak sevk edilir.  
 Floor joint profile for 15 cm width under finishing.  
 Delivered in assembled.

**TEKNİK ÖZELLİKLER / TECHNICAL FEATURES**

Açıklık : 150 mm  
 Width : 150 mm  
 Yükseklik : 14-28-43-60 mm  
 Height : 14-28-43-60 mm  
 Yaya trafiğine dayanıklı  
 Resistant to pedestrian traffic.  
 Haraket Kapasitesi : ± 35mm  
 Movement Capacity : ± 35mm

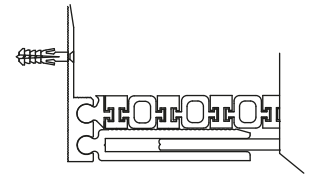
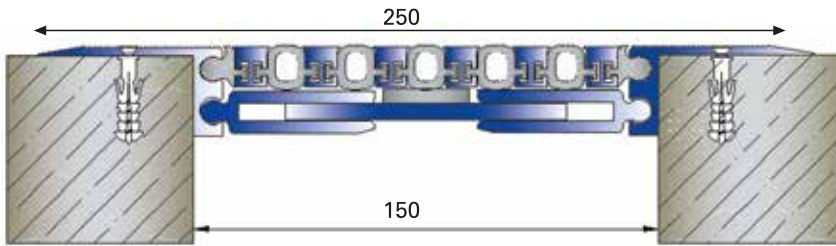
**AR303-151 H:14 / AR303-152 H:28**  
**AR303-153 H:60**

**AR174-150**

**AR174-150 KÖŞE DETAYI**  
**AR174-150 CORNER DETAIL**
**AÇIKLAMA / EXPLANATION**

15cm açıklık için kaplama üstü zemin dilatasyon profili.  
 Profil vida delikli ve montajlı olarak sevk edilir.  
 Floor joint profile for 15 cm width over finishing.  
 Delivered in assembled.

**TEKNİK ÖZELLİKLER / TECHNICAL FEATURES**

Açıklık : 150 mm  
 Width : 150 mm  
 Derinlik : 26 mm  
 Depth : 26 mm  
 Yaya trafiğine dayanıklı  
 Resistant to pedestrian traffic.  
 Haraket Kapasitesi : ± 35mm  
 Movement Capacity : ± 35mm



## AR801-150

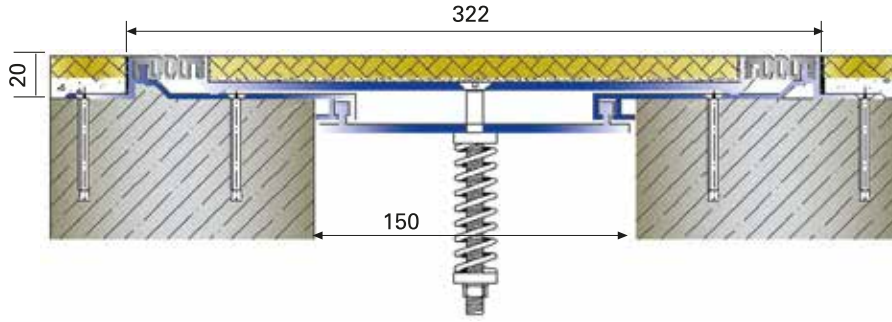

### AÇIKLAMA / EXPLANATION

15cm açıklık için kaplama altı zemin dilatasyon profili.  
Su izolasyonu, yangın bariyeri opsiyonel.  
Floor joint profile for 15 cm width under finishing.  
With optional water insulation or fire barrier.

### TEKNİK ÖZELLİKLER / TECHNICAL FEATURES

Açıklık : 150 mm  
Width: 150 mm  
Yükseklik : 20 mm  
Height: 20 mm  
Yaya trafiğine dayanıklı zeminde epoksi veya yapıştırma seramik duvar ve tavanda ise alçıpan ve sıva sıva uygulamalarına uygun.  
Suitable for epoxy applications on floor resistant to pedestrian traffic or plaster board and surface coat applications on adhesion type ceramic walls and ceiling.  
Haraket Kapasitesi:  $\pm 70$ mm  
Movement Capacity:  $\pm 70$ mm

## AR802-150

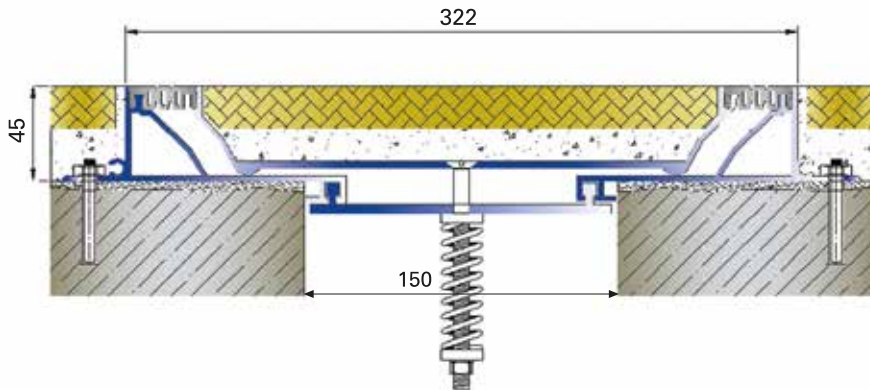

### AÇIKLAMA / EXPLANATION

15cm açıklık için sismik kaplama altı zemin dilatasyon profili.  
Su izolasyonu, yangın bariyeri opsiyonel.  
Floor joint profile for 15cm width for under plaster.  
With optional water isolation, fire barrier.

### TEKNİK ÖZELLİKLER / TECHNICAL FEATURES

Açıklık : 150 mm  
Width: 150 mm  
Yükseklik : 45 mm  
Height: 45 mm  
Yaya trafiğine dayanıklı  
Resistant to foot traffic.  
Haraket Kapasitesi:  $\pm 70$ mm  
Movement Capacity:  $\pm 70$ mm

## AR814-150

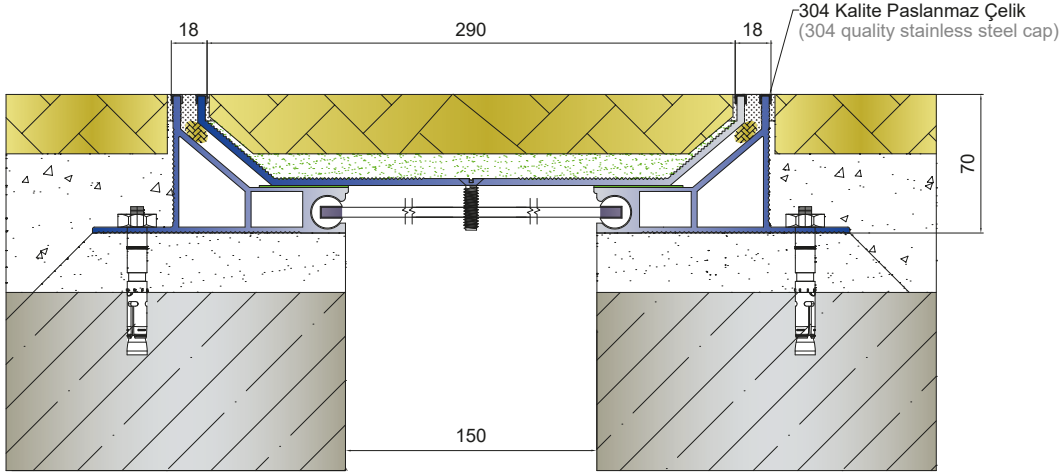

## AÇIKLAMA / EXPLANATION

15 cm açıklık için mastik uygulamalı sismik kaplama altı zemin dilatasyon profili. Paslanmaz üst yüzey ve alüminyum yüzey alternatifli dekoratif dilatasyon profilidir. Orta sistem ile alt profil arasında ses izolasyonu sağlayan TPE yastık mevcuttur. This seismic expansion joint profile is installed with epoxy mortar. It has stainless steel cover alternative and aluminium alternative. There is TPE sound absorber between middle profile and side leg.

## TEKNİK ÖZELLİKLER / TECHNICAL FEATURES

Açıklık : 150 mm  
Width: 150 mm  
Yükseklik : 70 mm  
Height: 70 mm  
Yaya trafiğine dayanıklı  
Resistant to pedestrian traffic  
Haraket Kapasitesi: ± 75mm  
Movement Capacity: ± 75mm  
Profil Boyu: 3mt.  
Profile Length: 3mt.

## AR814-151

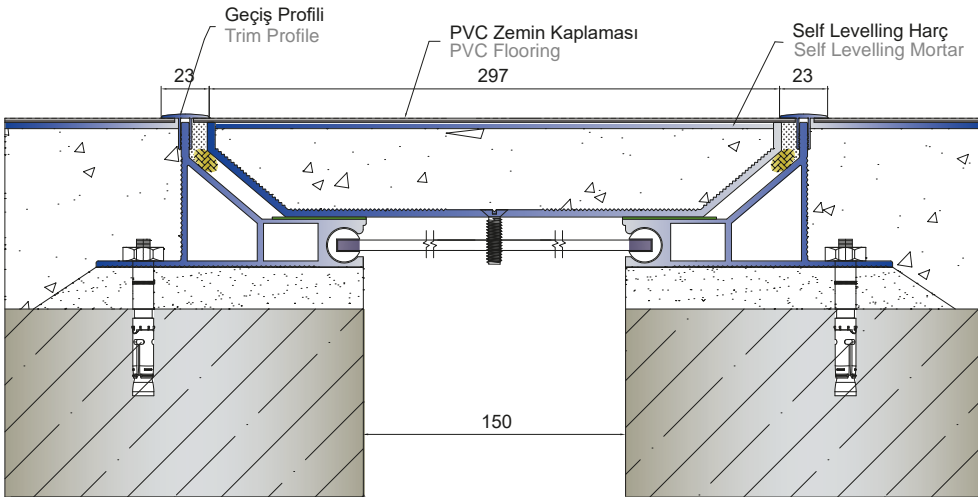

## AÇIKLAMA / EXPLANATION

15 cm açıklık için mastik uygulamalı sismik kaplama altı zemin dilatasyon profili. PVC, halı ve farklı bir çok zemin kaplamasında alüminyum üst görünüşlü dilatasyon profilidir. Orta sistem ile alt profil arasında ses izolasyonu sağlayan TPE yastık mevcuttur. This seismic expansion joint profile is installed with epoxy mortar. It has a trim profile which can cover many type of floor materials such as PVC flooring, carpet etc. There is TPE sound absorber between middle profile and side leg.

## TEKNİK ÖZELLİKLER / TECHNICAL FEATURES

Açıklık : 150 mm  
Width: 150 mm  
Yükseklik : 70 mm  
Height: 70 mm  
Yaya trafiğine dayanıklı  
Resistant to pedestrian traffic  
Haraket Kapasitesi: ± 75mm  
Movement Capacity: ± 75mm  
Profil Boyu: 3mt.  
Profile Length: 3mt.

## AR823-151

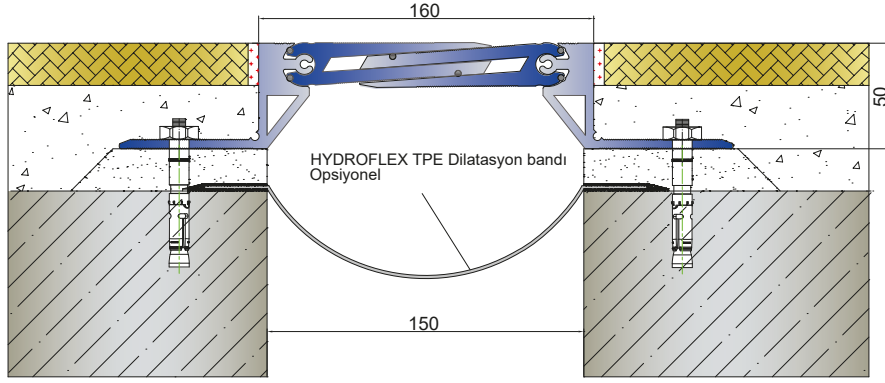

### AÇIKLAMA / EXPLANATION

Alışveriş merkezleri, iş merkezleri her türlü hastane ve kamu binaları gibi yapılarda hafif taşıt trafiğine ve yoğun yaya trafiğine dayanıklı kaplama altı zemin dilatasyon profilidir.

For shopping mall, residential building all types of hospitals and public buildings, this system is suitable for intensive pedestrian loads and vehicle traffic.

### TEKNİK ÖZELLİKLER / TECHNICAL FEATURES

Açıklık : 150 mm  
Width: 150 mm  
Yükseklik : 50 mm  
Height: 50 mm  
6 ton araç yüküne 3,5 ton forklift yüküne dayanıklı  
Resistant to 6 tones vehicle traffic and 3,5 tones forklift traffic  
Haraket Kapasitesi: ± 20mm  
Movement Capacity: ± 20mm  
Profil Boyutu: 4mt.  
Profile Length: 4mt.

## AR823-150

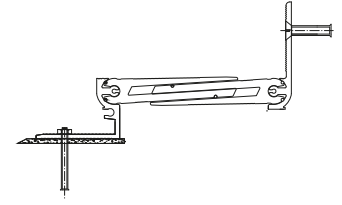
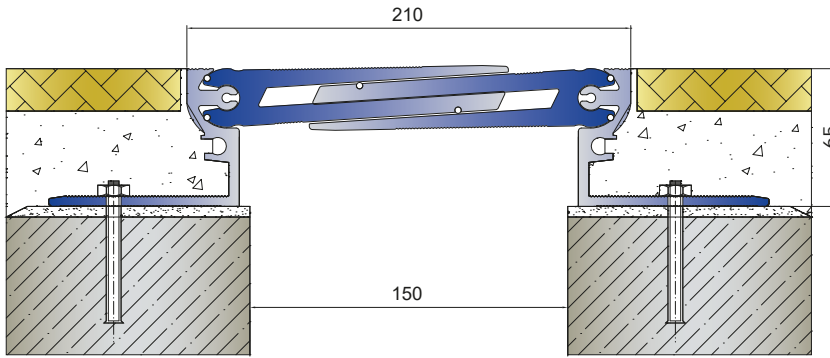

AR823-150 KÖŞE DETAYI  
AR823-150 CORNER DETAIL

### AÇIKLAMA / EXPLANATION

Endüstriyel zeminler, alışveriş merkezleri, fabrikalar ve depolar gibi yoğun araç ve forklift trafiğine maruz alanlarda kullanılan zemin dilatasyon profilleri.

This expansion joint profile is used for industrial floors, factory and warehouses. It is resistant for heavy vehicle and forklift traffic.

### TEKNİK ÖZELLİKLER / TECHNICAL FEATURES

Açıklık : 150 mm  
Width: 150 mm  
Yükseklik : 65 mm  
Height: 65 mm  
30 ton araç yükü, 6,5 ton aks yüküne dayanıklı  
Resistant to 30 tones vehicle and 6,5 tones forklift axle load  
Haraket Kapasitesi: -25mm / +30mm  
Movement Capacity: -25mm / +30mm  
Profil Boyutu: 4mt.  
Profile Length: 4mt.

## AR883-150

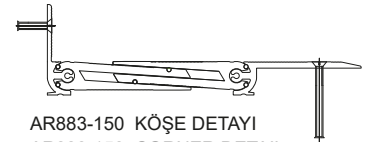
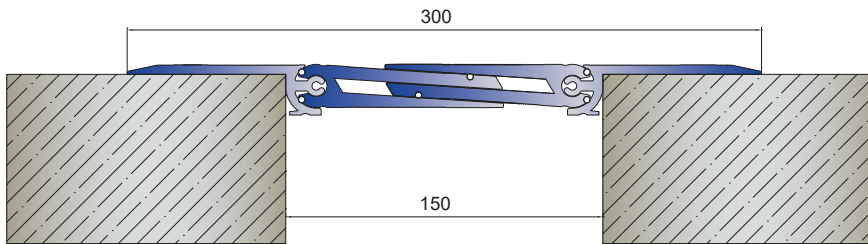

AR883-150 KÖŞE DETAYI  
AR883-150 CORNER DETAIL

### AÇIKLAMA / EXPLANATION

Kaplama üstü düz yüzeyli zemin dilatasyon profili. Profil montajlı ve vida delikleri açılmış olarak sevk edilir. A floor dilatation profile which has smooth surface on the overlay. It is delivered in assembled with screw holes.

### TEKNİK ÖZELLİKLER / TECHNICAL FEATURES

Açıklık : 150 mm  
Width: 150 mm  
3,5 ton araç yükü 2 ton forklift yüküne dayanıklı.  
Resistant to 3,5 tones the vehicle load and 2 tones the forklift load.  
Haraket Kapasitesi: ± 25mm  
Movement Capacity: ± 25mm  
Profil Boyutu: 4mt.  
Profile Length: 4mt.



**AR813-150**

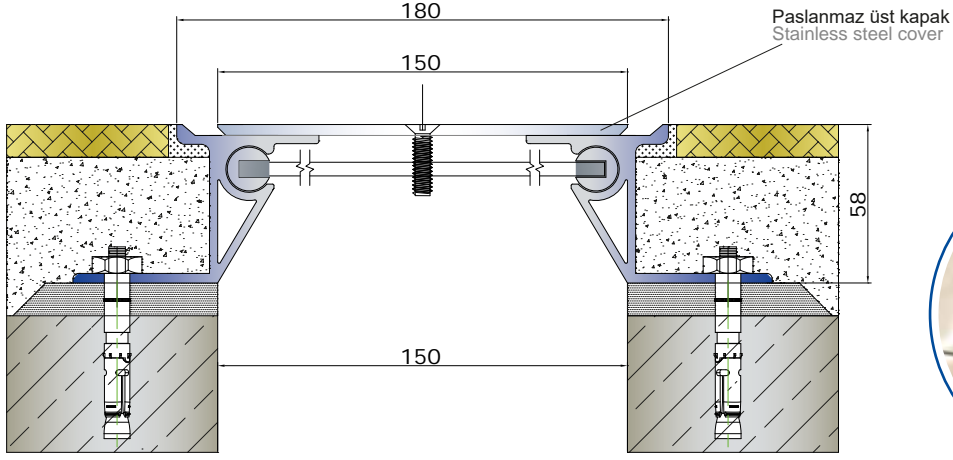

**AÇIKLAMA / EXPLANATION**

Yüksek hareket kapasitesi, aşınma dayanımı ve kimyasallara dayanım istenen alanlarda (alışveriş merkezleri, metro istasyonları, gıda ve ilaç tesisleri) kullanılan paslanmaz üst yüzeyli kaplama altı zemin dilatasyon profilidir. Epdm buhar bariyeri opsiyonel.

Stainless steel top covered profile is used for many places where high movement capacity and abrasive strength and chemical strength is necessary. Epdm vapour barrier is optional.

**TEKNİK ÖZELLİKLER / TECHNICAL FEATURES**

Açıklık : 150 mm  
Width: 150 mm  
Yükseklik : 48 mm  
Height: 48 mm  
3 ton araç trafiğine dayanıklı  
Resistant to 3 tones of the vehicle traffic  
Haraket Kapasitesi: ± 50mm  
Movement Capacity: ± 50mm  
Profil Boyu: 3mt.  
Profile Length: 3mt

**AR951-150**

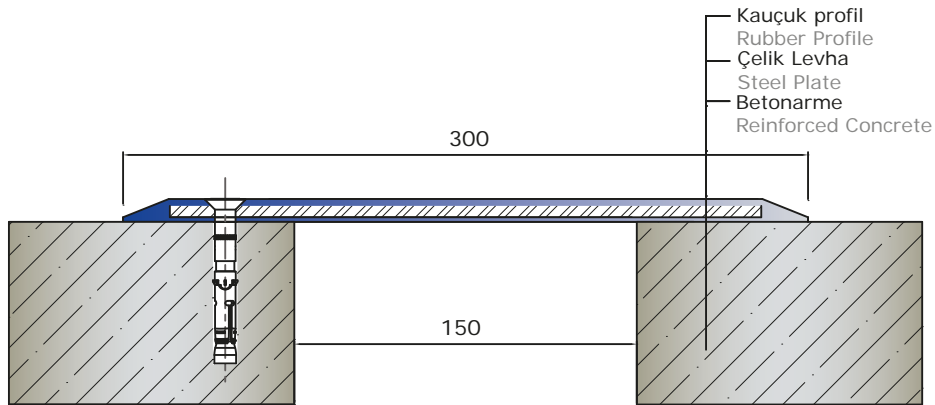

**AÇIKLAMA / EXPLANATION**

Otopark dilatasyonlarında kullanılan, ST37 çelik ve kauçuktan mamul, zemin dilatasyon profili.

This system is suitable for intensive car traffic areas such as circulation area in factory and warehouses and shopping malls.

**TEKNİK ÖZELLİKLER / TECHNICAL FEATURES**

Açıklık : 150 mm  
Width: 150 mm  
Yükseklik : 10 mm  
Height: 10 mm  
9 ton araç, 2.5 ton forklift yüküne dayanıklı  
9 ton vehicle, 2.5 ton forklift capacity  
Profil Boyu: 2mt.  
Profile Length: 2mt



## AR911-150

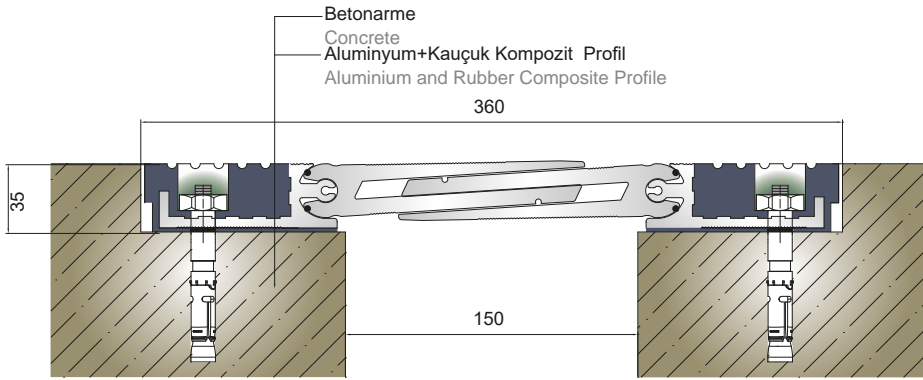

### AÇIKLAMA / EXPLANATION

Otopark, endüstriyel yapılar için alüminyum ve kauçuktan mamul kompozit dilatasyon profili.  
This system is made of from aluminium and rubber material. It is used for carpark and industrial plants.

### TEKNİK ÖZELLİKLER / TECHNICAL FEATURES

Açıklık : 150 mm  
Width : 150 mm  
Yükseklik : 35 mm  
Height : 35 mm  
6,5 ton araç yüküne, 3,5 ton forklift yüküne dayanıklı  
It is resistant to 6,5 tones vehicle load and 3,5 tones forklift traffic  
Haraket Kapasitesi : -25mm / +35mm  
Movement Capacity: -25mm / +35mm  
Profil Boyu : 2mt.  
Profile Length: 2mt.

## AR911-200

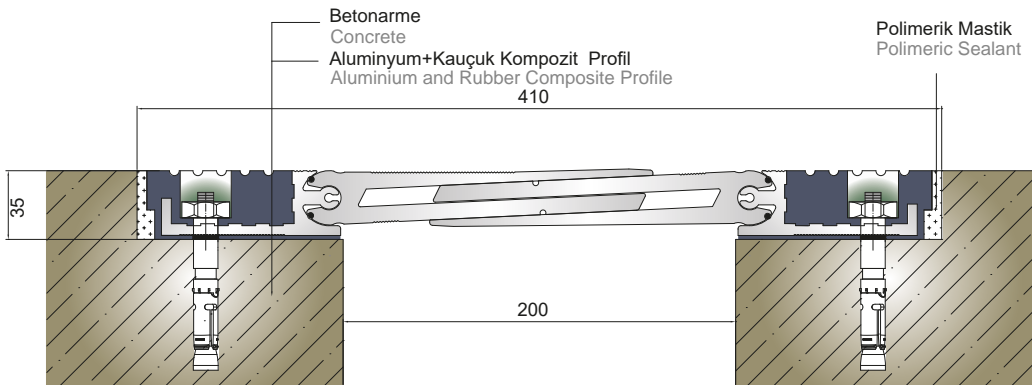

### AÇIKLAMA / EXPLANATION

Otopark, endüstriyel yapılar için alüminyum ve kauçuktan mamul kompozit dilatasyon profili.  
This system is made of from aluminium and rubber material. It is used for carpark industrial plants.

### TEKNİK ÖZELLİKLER / TECHNICAL FEATURES

Açıklık : 200 mm  
Width : 200 mm  
Yükseklik : 35 mm  
Height : 35 mm  
6,5 ton araç yüküne, 3,5 ton forklift yüküne dayanıklı  
It is resistant to 6,5 tones vehicle load and 3,5 tones forklift traffic  
Haraket Kapasitesi : ± 40mm  
Movement Capacity: ± 40mm  
Profil Boyu: 2mt.  
Profile Length: 2mt.

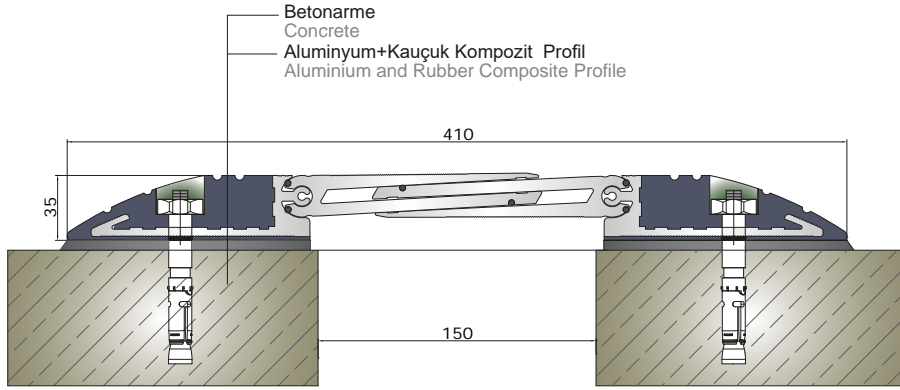

**AR921-150**

**AÇIKLAMA / EXPLANATION**

Otopark dilatasyonlarında kullanılan, alüminyum ve kauçuktan mamul, kasis özellikli, rampa tipi kompozit dilatasyon profili.  
 This over finishing system looks like a ramp profile and it is used for passing wide span gap. Aluminium profile and rubber are vulcanised together and it behaves like one material. It is suitable for all type of carpark areas.

**TEKNİK ÖZELLİKLER / TECHNICAL FEATURES**

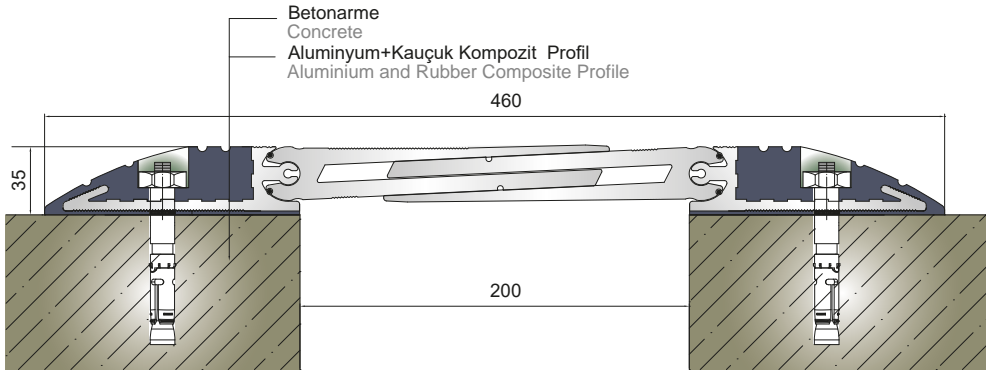
Açıklık : 150 mm  
 Width: 150 mm  
 Yükseklik : 35 mm  
 Height: 35 mm  
 6,5 ton araç yüküne dayanıklı. Kaymaya karşı yüzeyi çizgili.  
 It is resistant to 6,5 tones vehicle traffic  
 Haraket Kapasitesi : -25mm / +35mm  
 Movement Capacity: -25mm / +35mm  
 Profil Boyu: 2mt.  
 Profile Length: 2mt.

**AR921-200**

**AÇIKLAMA / EXPLANATION**

Otopark dilatasyonlarında kullanılan, alüminyum ve kauçuktan mamul, kasis özellikli, rampa tipi kompozit dilatasyon profili.  
 This over finishing system looks like a ramp profile and it is used for passing wide span gap. Aluminium profile and rubber are vulcanised together and it behaves like one material. It is suitable for all type of carpark areas.

**TEKNİK ÖZELLİKLER / TECHNICAL FEATURES**

Açıklık : 200 mm  
 Width: 200 mm  
 Yükseklik : 35 mm  
 Height: 35 mm  
 6,5 ton araç yüküne dayanıklı. Kaymaya karşı yüzeyi çizgili.  
 It is resistant to 6,5 tones vehicle traffic  
 Haraket Kapasitesi: ± 40mm  
 Movement Capacity: ± 40mm  
 Profil Boyu: 2mt.  
 Profile Length: 2mt.



## AR262-152

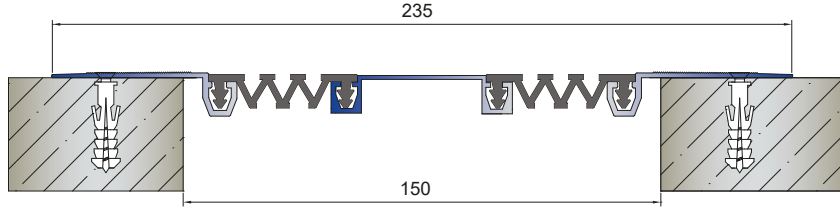

### AÇIKLAMA / EXPLANATION

Eloksalli, sıva üstü vida delikli duvar tavan dilatasyon profili.  
Anodised expansion joint profile for over plaster.

### TEKNİK ÖZELLİKLER / TECHNICAL FEATURES

Açıklık : 150 mm  
Width: 150 mm  
Derinlik : 15 mm  
Depth: 15 mm  
Haraket Kapasitesi:  $\pm 50$ mm  
Movement Capacity:  $\pm 50$ mm  
Profil Boyutu: 3mt.  
Profile Length: 3mt.



## AR295-150

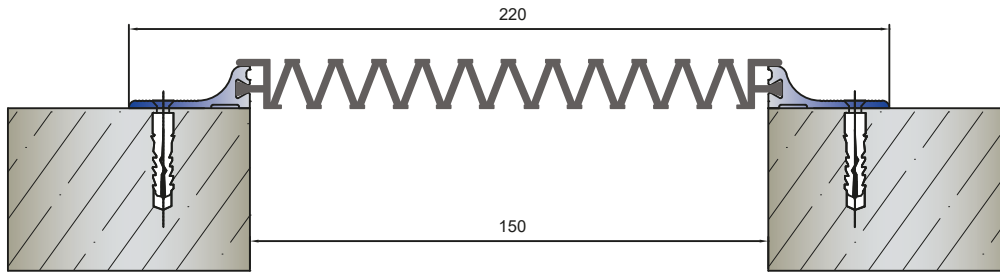

### AÇIKLAMA / EXPLANATION

Sıva Üstü Duvar Tavan Dilatasyon Profili  
Özleikle dış cephe uygulamalarında geniş açıklıklarda kullanılır.  
Eloksalli ve pres alternatifleri mevcuttur.  
Wall and ceiling profile joint with screw holes.  
It is used for facades ,columns and walls with it's wide side.

### TEKNİK ÖZELLİKLER / TECHNICAL FEATURES

Açıklık : 150 mm  
Width: 150 mm  
Derinlik : 14 mm  
Depth: 14 mm  
Haraket Kapasitesi:  $\pm 130$ mm  
Movement Capacity:  $\pm 130$ mm  
Profil Boyutu: 3mt.  
Profile Length: 3mt.



## AR259-150

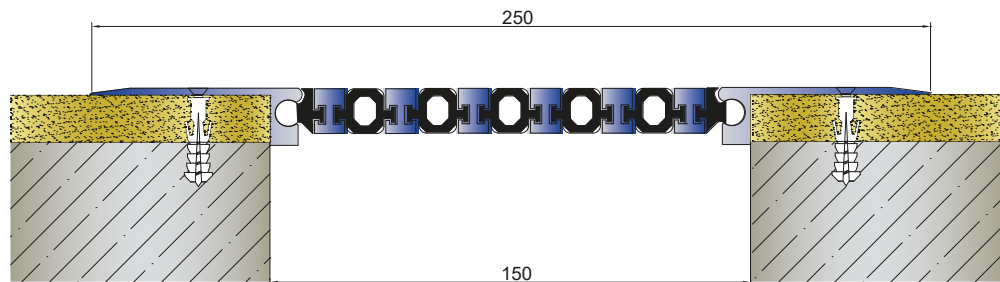

### AÇIKLAMA / EXPLANATION

Sıva üstü duvar tavan dilatasyon profili.  
Profil vida delikli ve montajlı olarak sevki edilir.  
Wall and ceiling expansion joint profile for over finishing.  
It is compatible with AR303-150 and AR174-150

### TEKNİK ÖZELLİKLER / TECHNICAL FEATURES

Açıklık : 150 mm  
Width: 150 mm  
Derinlik : 15 mm  
Depth: 15 mm  
Haraket Kapasitesi:  $\pm 35$ mm  
Movement Capacity:  $\pm 35$ mm  
Profil Boyutu: 3mt.  
Profile Length: 3mt.





## AR 291-150

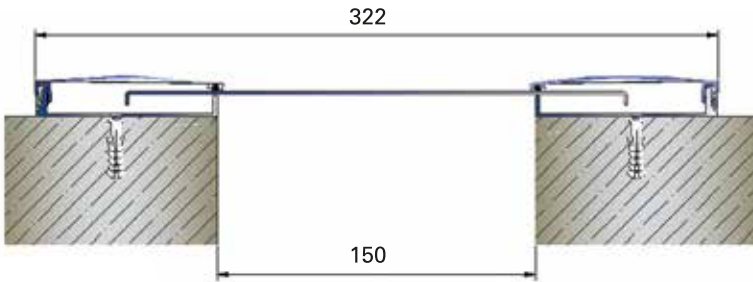

## AÇIKLAMA / EXPLANATION

15cm açıklık için sismik kaplama üstü duvar tavan dilatasyon profili. 50cm ara ile kullanılan çelik yaylara üst kapak bastırılarak takılır. Su izolasyonu, yangın bariyeri opsiyonel. Wall and ceiling dilatation profile for 15cm width. It is used for over finishing. Push the top cover to the steel springs used in every 50 cms. With optional water isolation barrier of the barrier.

## TEKNİK ÖZELLİKLER / TECHNICAL FEATURES

Açıklık : 150 mm  
Width: 150 mm  
Yükseklik : 16 mm  
Height: 16 mm  
AR802-150 ile tam uyumlu  
Compatible with AR802-150  
Haraket Kapasitesi: ± 70mm  
Movement Capacity: ± 70mm

## AR 291-150 K

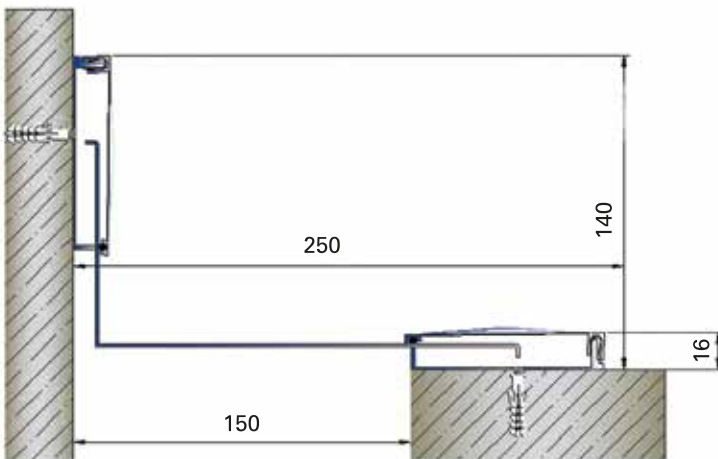

## AÇIKLAMA / EXPLANATION

15cm açıklık için sismik kaplama üstü duvar tavan köşe dilatasyon profili. 50cm ara ile kullanılan çelik yaylara üst kapak bastırılarak takılır. Su izolasyonu, yangın bariyeri opsiyonel. Wall and ceiling corner dilatation profile for 15cm width. It is used for over finishing. Push the top cover to the steel springs used in every 50 cm. With optional water isolation barrier of the barrier.

## TEKNİK ÖZELLİKLER / TECHNICAL FEATURES

Açıklık : 150 mm  
Width: 150 mm  
Yükseklik : 16 mm  
Height: 16 mm  
AR802-150 ile tam uyumlu  
Compatible with AR802-150  
Haraket Kapasitesi: ± 35mm  
Movement Capacity: ± 35mm

## AR823-200

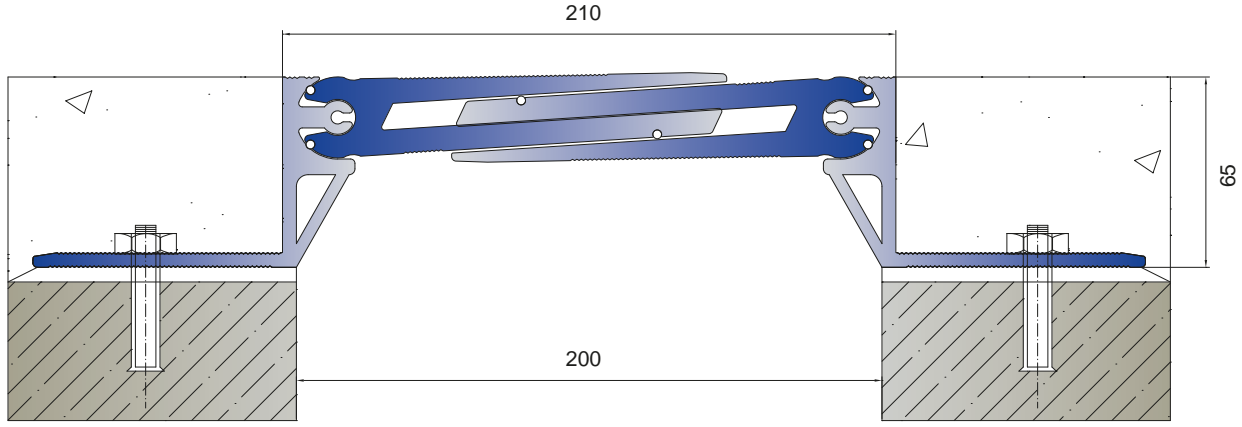

### AÇIKLAMA / EXPLANATION

Endüstriyel zeminler, alveriş merkezleri, fabrikalar ve depolar gibi yoğun araç ve forklift trafiğine maruz alanlarda kullanılan zemin dilatasyon profilleri.

This expansion joint profile is used for industrial floors, factory and warehouses. It is resistant for heavy vehicle and forklift traffic.

### TEKNİK ÖZELLİKLER / TECHNICAL FEATURES

Açıklık : 200 mm

Width : 200 mm

Yükseklik : 65 mm

Height : 65 mm

15 ton araç yükü, 5 ton forklift yüküne dayanıklı

Resistant to 15 tones vehicle and 5 tones forklift axle load

Haraket Kapasitesi: -25mm / +30mm

Movement Capacity: -25mm / +30mm

Profil Boyutu: 4mt.

Profile Length: 4mt.

## AR303-200

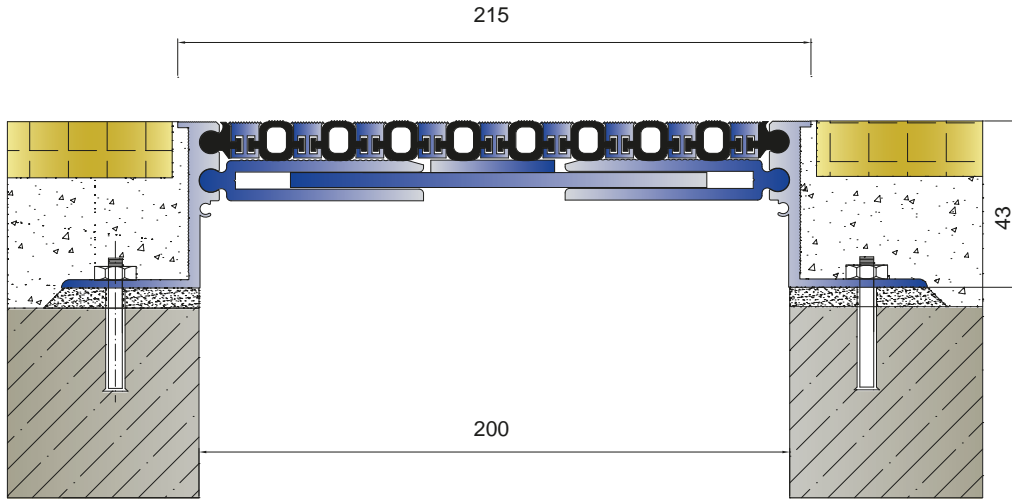

### AÇIKLAMA / EXPLANATION

20cm açıklık için kaplama altı zemin dilatasyon profili.  
Profil montajlı olarak sevk edilir.

Floor joint profile for 20 cm width under finishing.  
Delivered in assembled.

### TEKNİK ÖZELLİKLER / TECHNICAL FEATURES

Açıklık : 200 mm

Width : 200 mm

Yükseklik : 14-28-43-60 mm

Height : 14-28-43-60 mm

Yaya trafiğine dayanıklı

Resistant to pedestrian traffic.

Haraket Kapasitesi: ± 35mm

Movement Capacity: ± 35mm

**AR814-200**

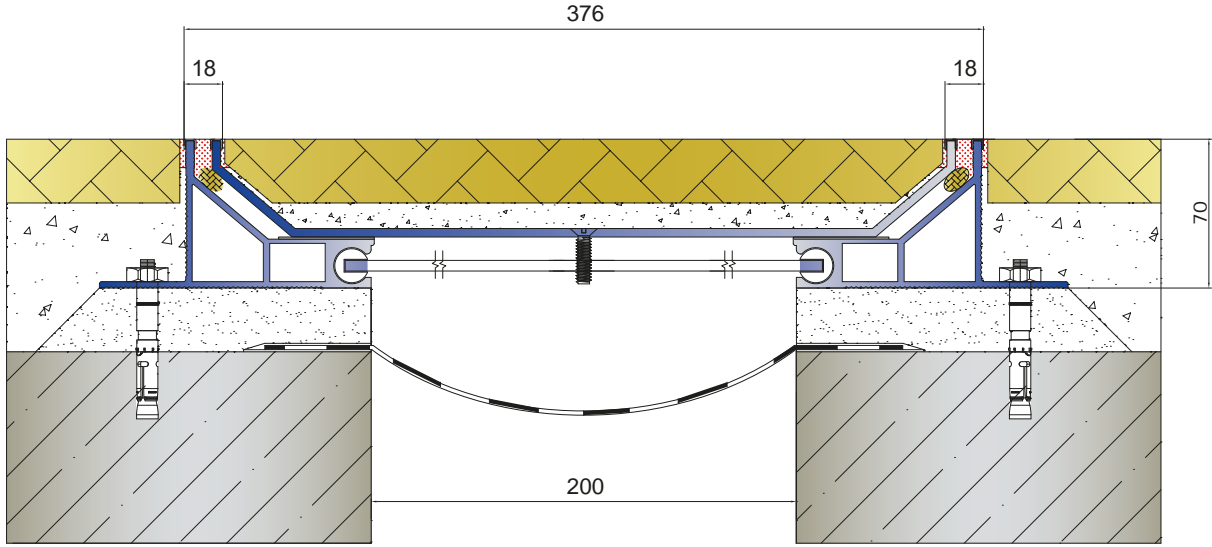

**AÇIKLAMA / EXPLANATION**

20 cm açıklık için mastik uygulamalı sismik kaplama altı zemin dilatasyon profili. Paslanmaz üst yüzey ve alüminyum yüzey alternatifli dekoratif dilatasyon profilidir. Orta sistem ile alt profil arasında ses izolasyonu sağlayan TPE yastık mevcuttur. This seismic expansion joint profile is installed with epoxy mortar. It has stainless steel cover alternative and aluminium alternative. There is TPE sound absorber between middle profile and side leg.

**TEKNİK ÖZELLİKLER / TECHNICAL FEATURES**

Açıklık : 200 mm  
Width: 200 mm  
Yükseklik : 70 mm  
Height: 70 mm  
Yaya trafiğine dayanıklı  
Resistant to pedestrian traffic  
Haraket Kapasitesi: ± 75mm  
Movement Capacity: ± 75mm  
Profil Boyu: 3mt.  
Profile Length: 3mt.

**AR883-200**

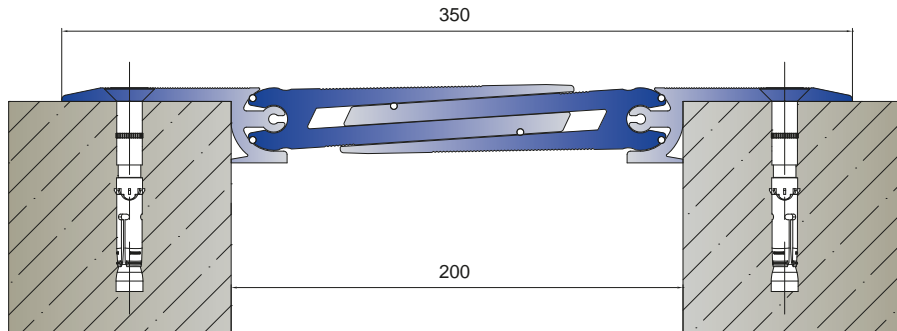

**AÇIKLAMA / EXPLANATION**

Kaplama üstü düz yüzeyli zemin dilatasyon profili. Profil montajı ve vida delikleri açılmış olarak sevk edilir. A floor dilatation profile which has smooth surface on the overlay. It is delivered in assembled with screw holes.

**TEKNİK ÖZELLİKLER / TECHNICAL FEATURES**

Açıklık : 200 mm  
Width: 200 mm  
3,5 ton araç yükü 2 ton forklift yüküne dayanıklı.  
Resistant to 3,5 tones the vehicle load and 2 tones the forklift load.  
Haraket Kapasitesi: -15mm / +40mm  
Movement Capacity: -15mm / +40mm  
Profil Boyutu: 4mt.  
Profile Length: 4mt.



## AR291-200

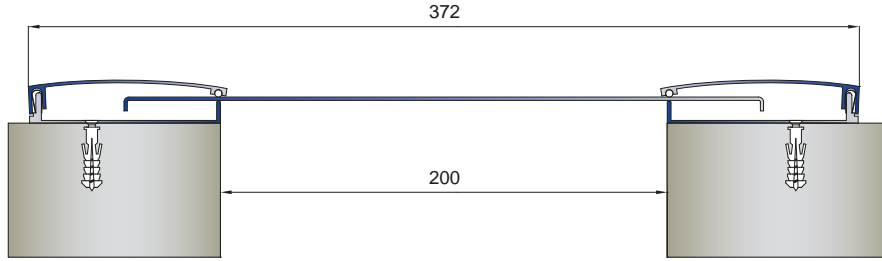

### AÇIKLAMA / EXPLANATION

20cm açıklık için sismik kaplama üstü duvar tavan dilatasyon profili. 50cm ara ile kullanılan çelik yaylara üst kapak bastırılarak takılır. Su izolasyonu, yangın bariyeri opsiyonel.

Wall and ceiling dilatation profile for 20cm width. It is used for over finishing. Push the top cover to the steel springs used in every 50 cms. With optional water isolation barrier of the barrier.

### TEKNİK ÖZELLİKLER / TECHNICAL FEATURES

Açıklık : 200 mm  
Width: 200 mm  
Yükseklik : 16 mm  
Height: 16 mm  
AR802-200 ile tam uyumlu  
Compatible with AR802-200  
Haraket Kapasitesi:  $\pm 70$ mm  
Movement Capacity:  $\pm 70$ mm



## AR291-200K

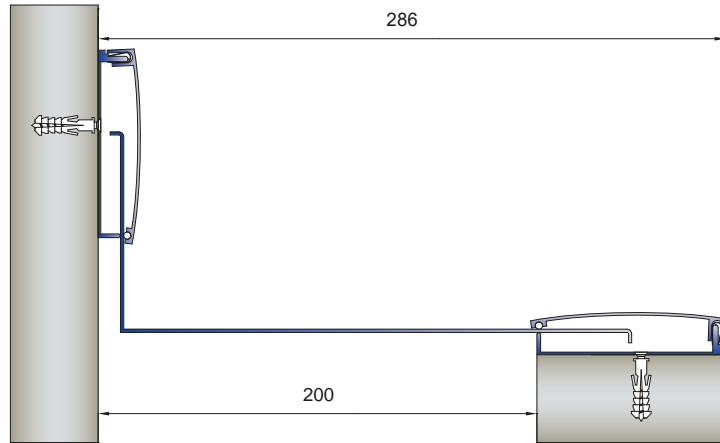

### AÇIKLAMA / EXPLANATION

20cm açıklık için sismik kaplama üstü duvar tavan köşe dilatasyon profili. 50cm ara ile kullanılan çelik yaylara üst kapak bastırılarak takılır. Su izolasyonu, yangın bariyeri opsiyonel.

Wall and ceiling corner dilatation profile for 20cm width. It is used for over finishing. Push the top cover to the steel springs used in every 50 cms. With optional water isolation barrier of the barrier.

### TEKNİK ÖZELLİKLER / TECHNICAL FEATURES

Açıklık : 200 mm  
Width: 200 mm  
Yükseklik : 16 mm  
Height: 16 mm  
AR802-200 ile tam uyumlu  
Compatible with AR802-200  
Haraket Kapasitesi:  $\pm 35$ mm  
Movement Capacity:  $\pm 35$ mm



**AR259-200**

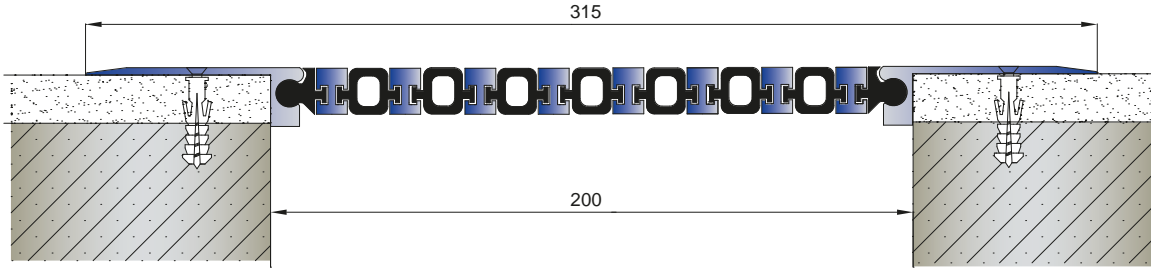

AR259-200 KÖŞE DETAYI  
AR259-200 CORNER DETAIL

**AÇIKLAMA / EXPLANATION**

Sıva Üstü Duvar Tavan Dilatasyon Profili  
Özlelikle dış cephe uygulamalarında geniş açıklıklarda kullanılır.  
Eloksalli ve pres alternatifleri mevcuttur.  
Wall and ceiling profile joint with screw holes.  
It is used for facades ,columns and walls with it's wide side.

**TEKNİK ÖZELLİKLER / TECHNICAL FEATURES**

Açıklık : 200 mm  
Width: 200 mm  
Derinlik : 14 mm  
Depth: 14 mm  
Haraket Kapasitesi: ± 180mm  
Movement Capacity: ± 180mm  
Profil Boyutu: 3mt.  
Profile Length: 3mt.

**AR295-200**

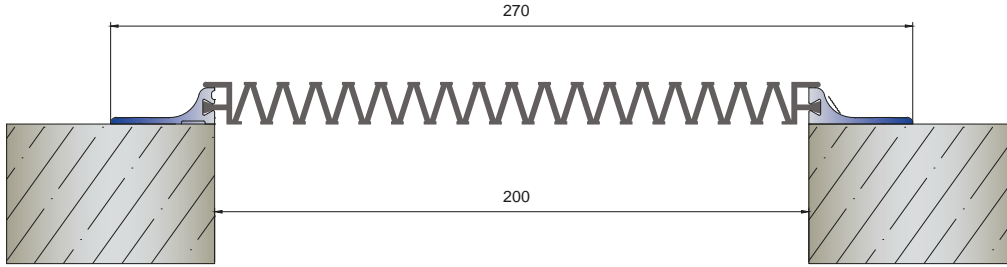

**AÇIKLAMA / EXPLANATION**

Sıva Üstü Duvar Tavan Dilatasyon Profili  
Özlelikle dış cephe uygulamalarında geniş açıklıklarda kullanılır.  
Eloksalli ve pres alternatifleri mevcuttur.  
Wall and ceiling profile joint with screw holes.  
It is used for facades ,columns and walls with it's wide side.

**TEKNİK ÖZELLİKLER / TECHNICAL FEATURES**

Açıklık : 200 mm  
Width: 200 mm  
Derinlik : 14 mm  
Depth: 14 mm  
Haraket Kapasitesi: ± 180mm  
Movement Capacity: ± 180mm  
Profil Boyutu: 3mt.  
Profile Length: 3mt.

**AR270 DT + BTA**

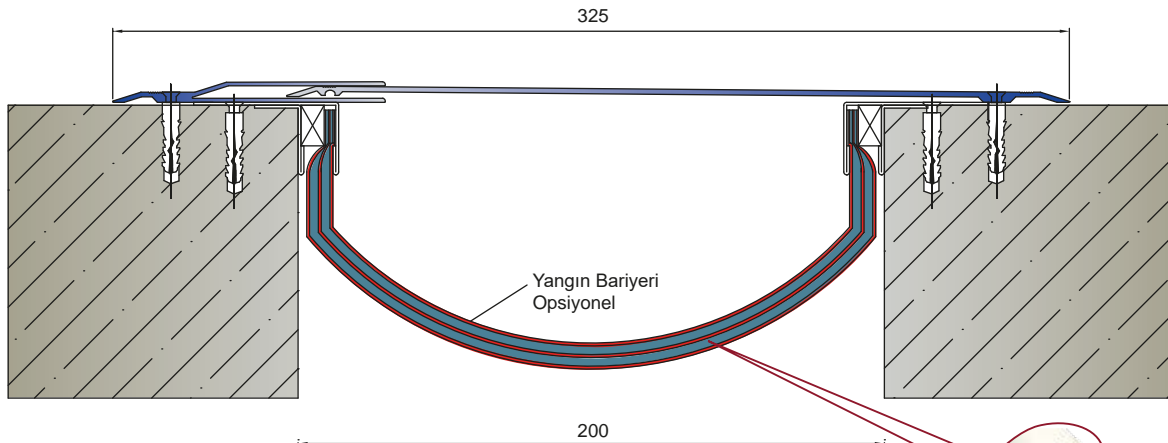

**AÇIKLAMA / EXPLANATION**

20cm açıklık için bitim aparatlı duvar tavan kapak dilatasyon profili.  
For 20cm gap. Expansion joint cover profile and finishing parts.



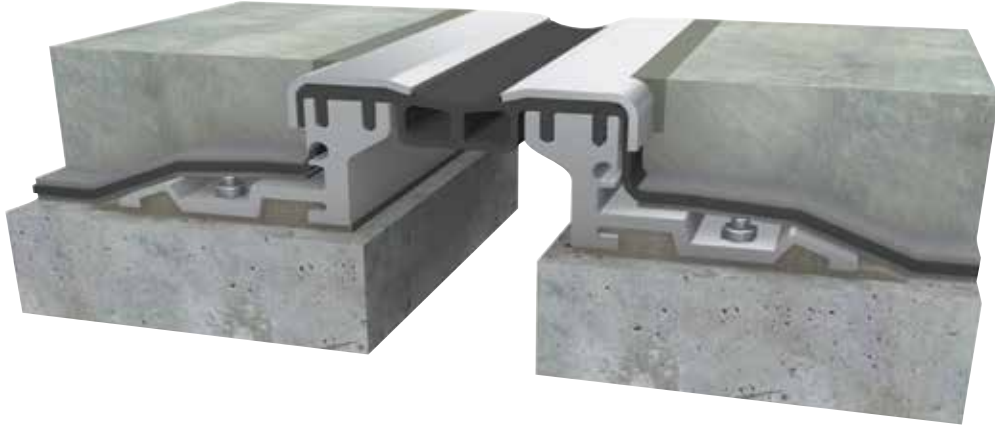

## AR600-050 Tam sızdırmaz dilatasyon detayı AR600-050 Watertight Expansion Joint

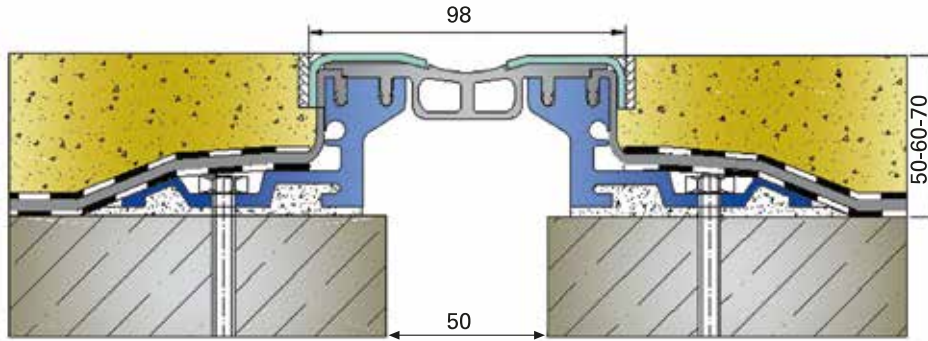

### AÇIKLAMA / EXPLANATION

Su izolasyonu gerektiren teraslar, otoparklar, ıslak hacimlerde tam sızdırmazlığı sağlayan bitümlü membranla uyumlu dilatasyon profili. Su izolasyonu üzerine ısı yalıtımı yapıldığında profil sistemi topuk betonu ile yükseltilir. Membran üzerine koruma amaçlı geotekstil kullanılması tavsiye edilir.

Dilatation profile suitable for terrace, parking areas that require water isolation and bituminous membranes that provide full tightness in wet areas. When thermal insulation is performed over water isolation, the profile system is raised with toe concrete. It is recommended to use geotextile over membrane for protection.

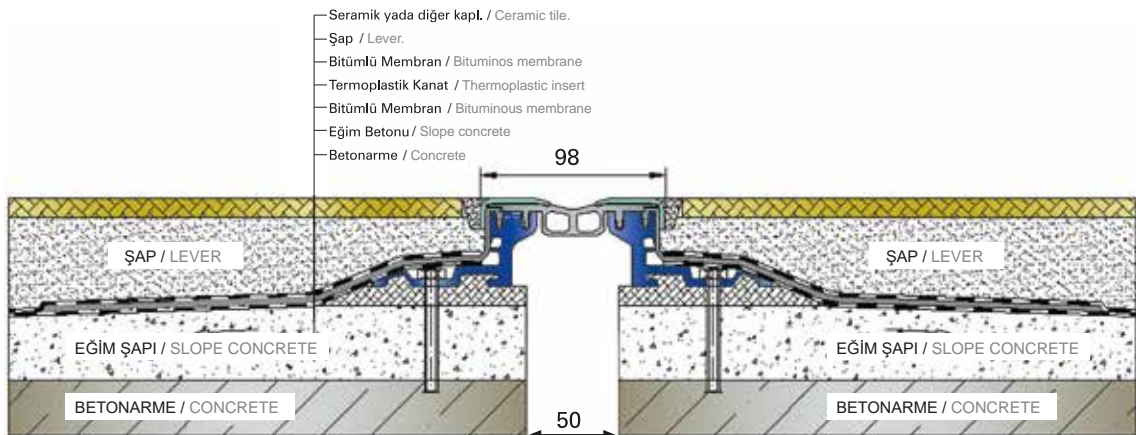

### TEKNİK ÖZELLİKLER / TECHNICAL FEATURES

15 ton araç ve 6 ton forklift trafiğine dayanıklı t:2,5mm paslanmaz üst kapaklı, 28cm genişliğinde termoplastik yan kanatlı, ek yerleri hava kaynağı ile birleşen köşe detayları mevcut ultraviyoleye dayanıklı dilatasyon profili. H: 50-60-70 mm Hareket Kapasitesi: ±10mm Dilatation profile resistant to 15 tones of vehicle and 6 tones of forklift traffic. t:2,5mm with stainless top cover, thermoplastic wing of 28cm width, corner details whose joints are integrated with air welding and resistant to current ultraviolet. H: 50-60-70 mm Movement Capacity: ±10mm



## AR600-050 K1 Islak Hacimler Köşe Dilatasyon Detayı AR600-050 K1 Corner Dilatation Detail for wet areas

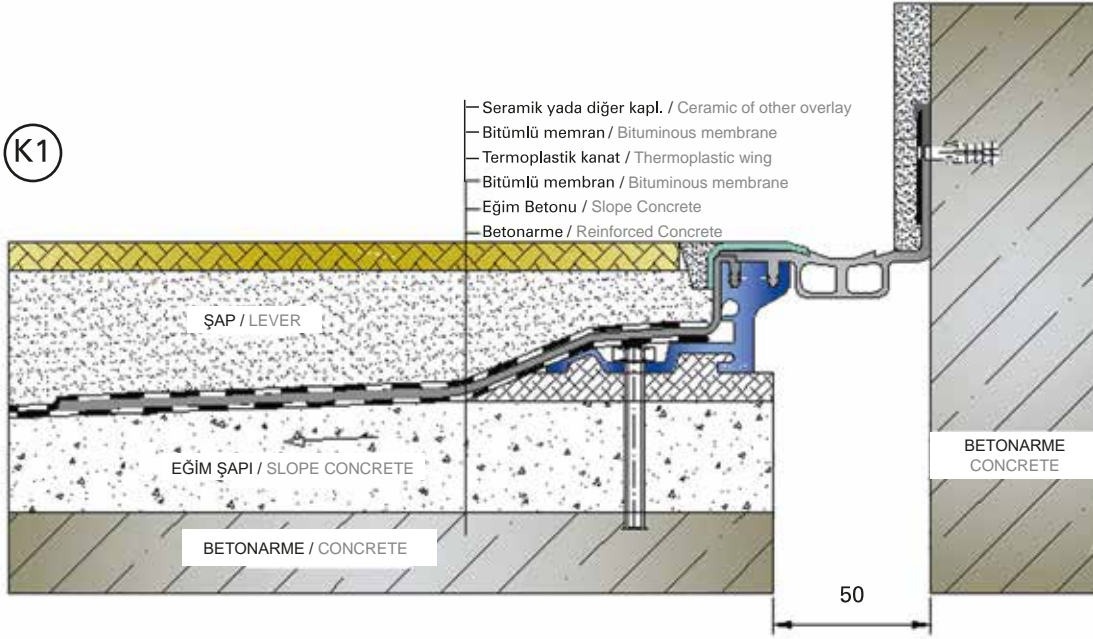

### AÇIKLAMA / EXPLANATION

Dilatasyon köşesinde sıva yada seramik uygulamasında kullanılan köşe detayıdır. Düz detay ile birleşiminde hava kaynağı ile düz ve köşe detay alın altına kaynaklanır.

It is the corner detail used in the plastering or ceramic application in the dilatation corner. For the integration with the plain detail, plain and corner details are merged face to face by air welding.



## AR600-050 K2 Islak Hacimler Köşe Dilatasyon Detayı AR600-050 K2 Corner Dilatation Detail for wet areas

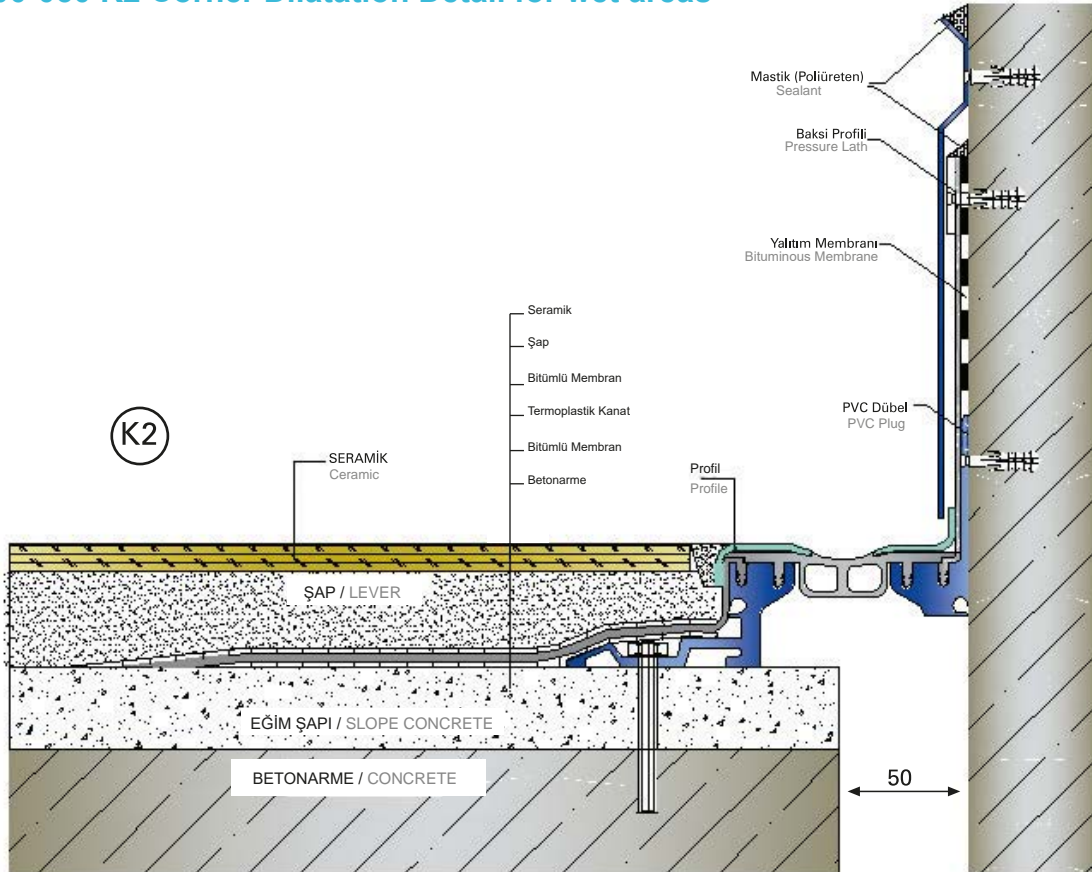

### AÇIKLAMA / EXPLANATION

Dilatasyon köşesinde giydirmeye cephe uygulaması durumunda kullanılan detaydır.

It is the detail used in curtain wall applications in dilatation corner





## AR600-100 Tam Sızdırmaz Dilatasyon Detayı AR600-100 Watertight Expansion Joint

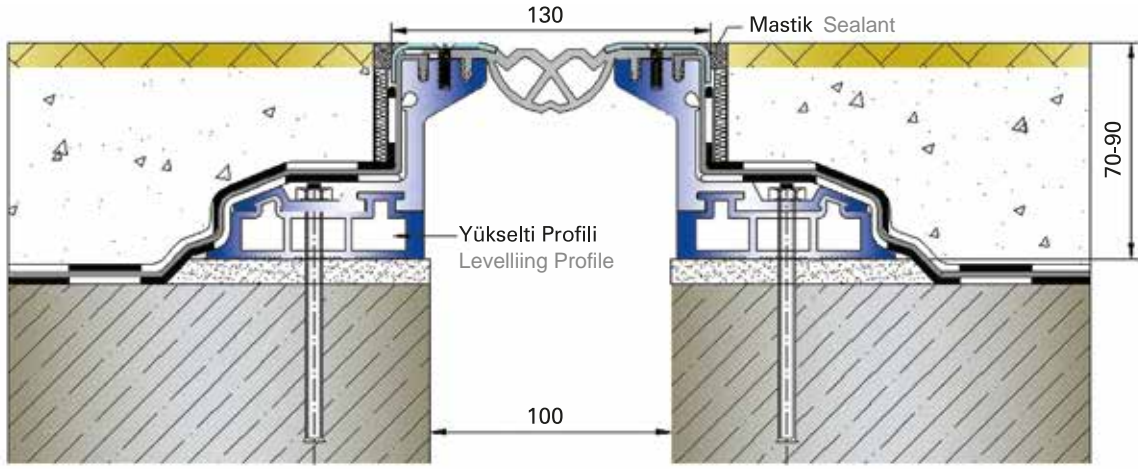

### AÇIKLAMA / EXPLANATION

Su izolasyonu gerektiren teraslar, otoparklar, ıslak hacimlerde tam sızdırmazlığı sağlayan bitümlü membranla uyumlu dilatasyon profili. Dilatation profile suitable for roofs, parking areas that require water isolation and bituminous membranes that provide full tightness in wet areas. Foot height of 70mm could be raised to 90mm with the levelling profile. By this way, total application height would be 10cm including the epoxy.

## AR600-100 Sızdırmaz Dilatasyon Detayı AR600-100 Watertight Expansion Joint

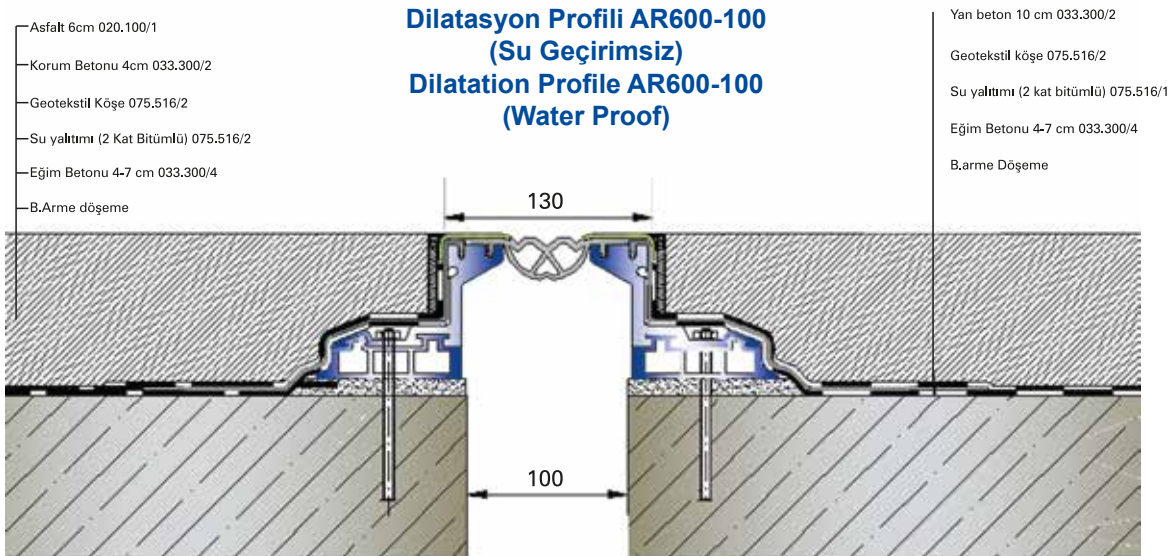

### TEKNİK ÖZELLİKLER / TECHNICAL FEATURES

15 ton araç ve 6 ton forklift trafiğine dayanıklı t:2,5mm paslanmaz üst kapaklı, 28cm genişliğinde termoplastik yan kanatlı, ek yerleri hava kaynağı ile birleşen köşe detayları mevcut ultraviyoleye dayanıklı dilatasyon profili. H: 70-90 mm Hareket Kapasitesi: ±20mm Dilatation profile resistant to 15 tones of vehicle and 6 tones of forklift traffic. t:2,5mm with stainless top cover, thermoplastic side wing of 28cm width, corner details whose joints are integrated with air welding and resistant to current ultraviolet. H: 70-90 mm Movement Capacity: ±20mm



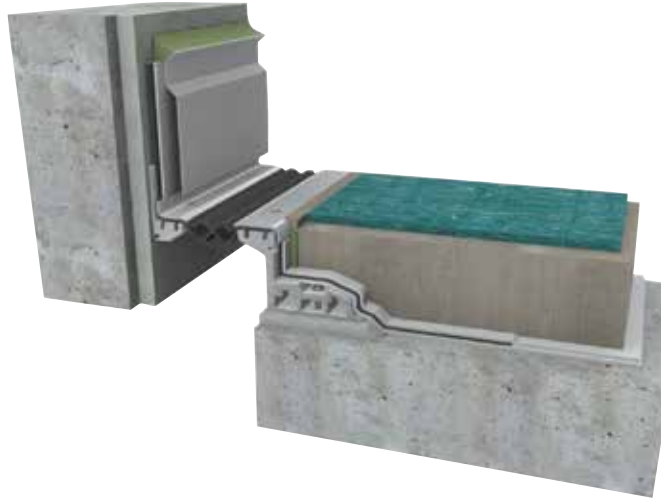

**AR600-100 K Islak Hacimler Köşe Dilatasyon Detayı**  
**AR600-100 K Corner Dilatation Detail for wet areas**

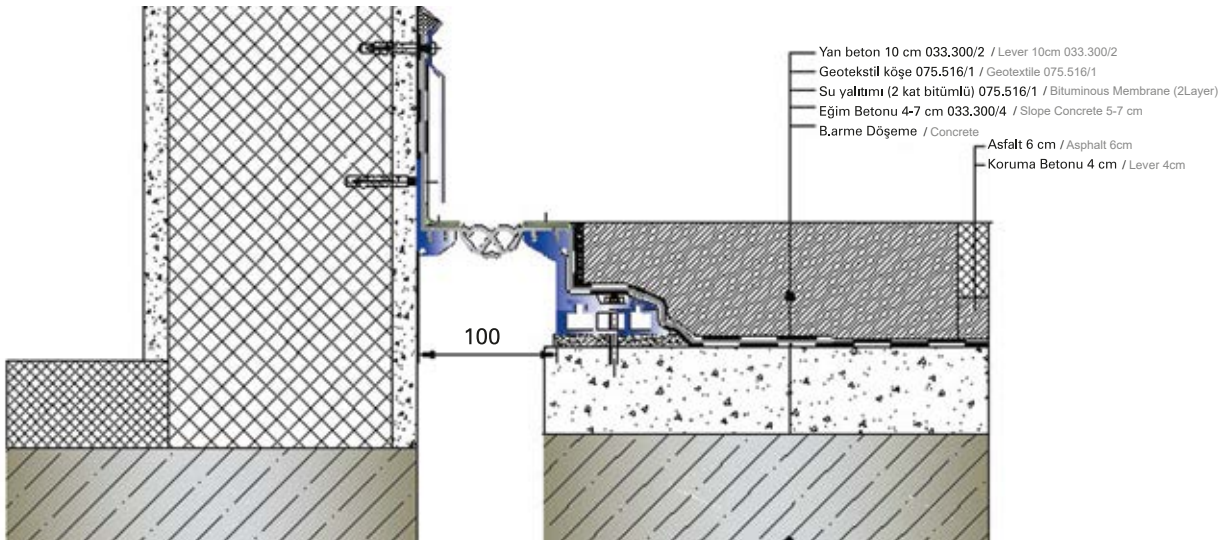
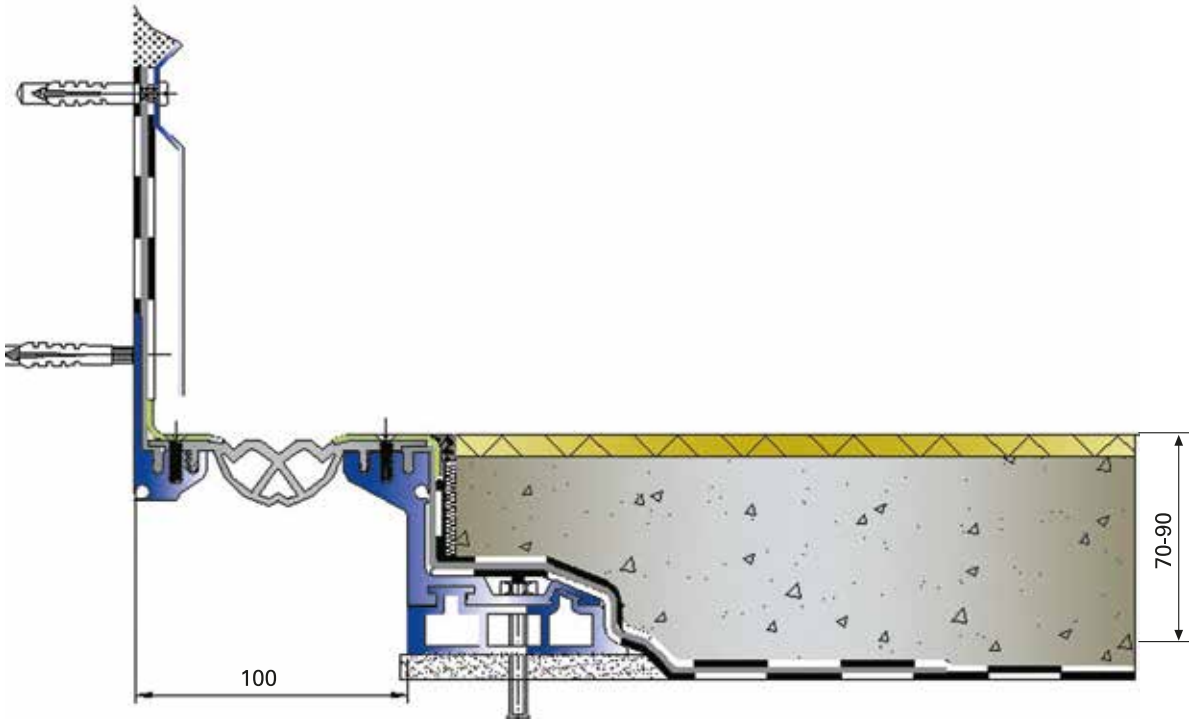

**AÇIKLAMA / EXPLANATION**

AR600-100 dilatasyon profili köşe detayıdır.  
It is the corner detail of AR600-100 dilatation profile



## Alüminyum Harpuşa Detayları Aluminium Wall Coping Details



### ARH 25

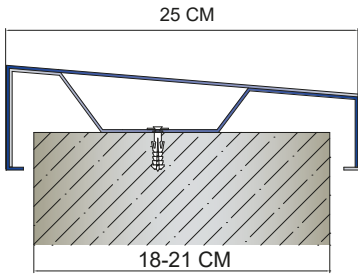

### ARH 30

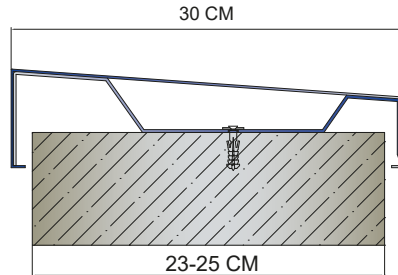

### ARH 35

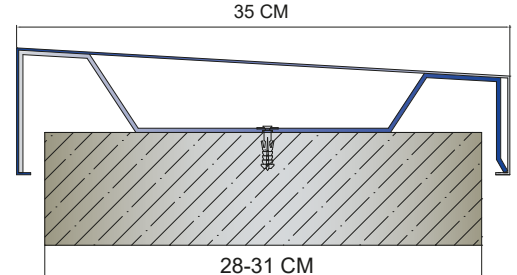

### AKSESUAR / ACCESSORIES

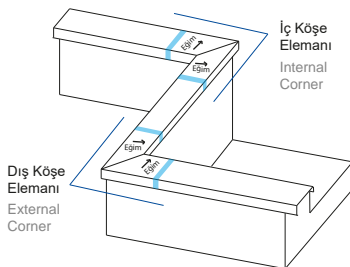

Dış Köşe ve İç Köşe Elemanı  
(External and Internal Corner Parts)

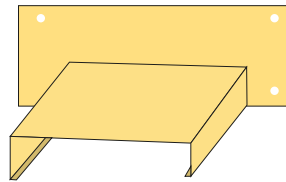

Duvar Dibi Özel Bitim Elemanı  
(Special Finishing Parts For Wall)



Ek Birleştirme Elemanı (H profil)  
(Connection Profile Between 2 Elements)

### AÇIKLAMA / EXPLANATION

Parapet genişliğine göre özel tasarım imkanı / Special design alternatives for according to parapet width.

Aksesuarları ile birlikte su sızdırmaz bir yapı / Watertight design with accessories

Doğru kalınlıklar ve montaj ile rüzgar yüklerine dayanım / Resistant to wind forces with accurate thickness and application method

Isıl genleşmelere uyumluluk / Compatible with thermal expansion

Renkli yada eloksalı çözümler / Anodised or electrostatic powder coating alternative

Yapısı gereği içe doğru eğiminin verilebilmesi / Because of it's structure slope can be made easily

Özel alaşımlı 70mm genişlikte 50cm ara ile kullanılan alt alüminyum halterler parapete sabitlendikten sonra eloksalı veya elektrotatik boyalı alüminyum harpuşalar halterlere klips şeklinde geçirilerek monte edilir. Farklı genişliklerdeki Parapetler için farklı ölçülerde özel olarak imalat yapılmaktadır.

70mm width special aluminium retainers are installed between 50cm distances along to parapet direction. Aluminium coping detail is installed over retainers with press. Connection parts must be used for every junction point to prevent water leakage. It can be produced different dimension for different inquiry.

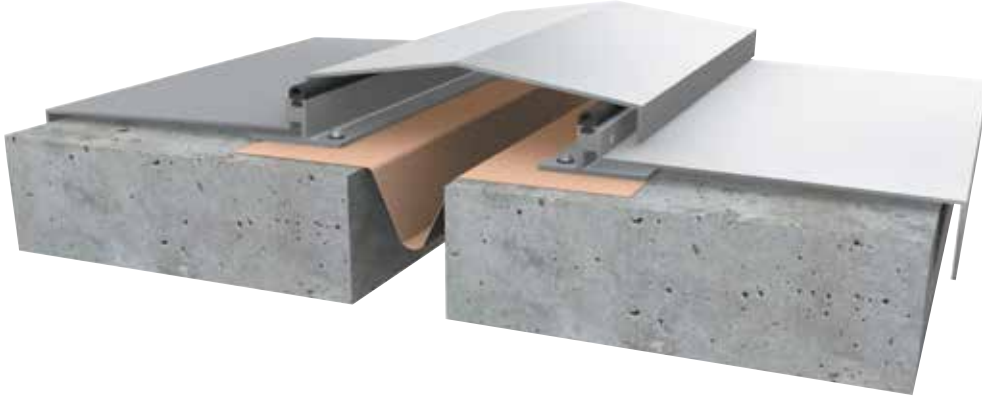

### AR606-100 Dilatasyon Detayı AR606-100 Expansion Joint Detail For Roof

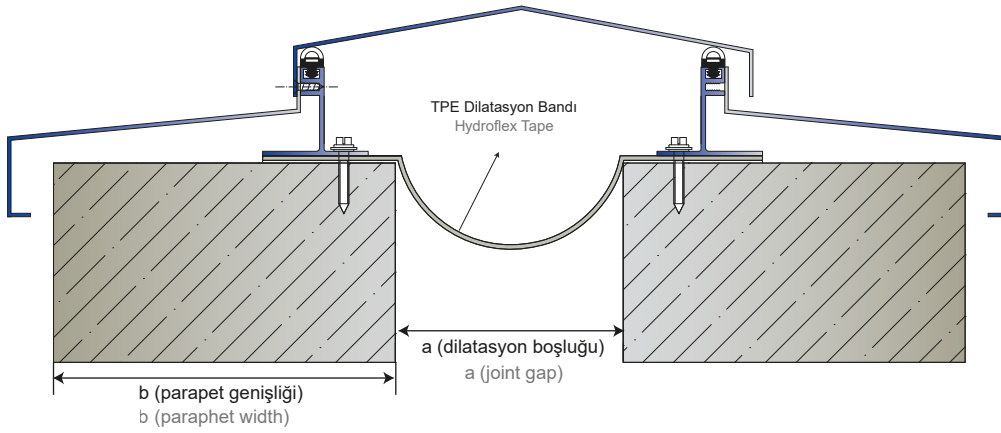

#### AÇIKLAMA / EXPLANATION

Teras çatılarda dilatasyon birleşiminde kullanılan harpuşta detayı. Farklı genişliklerdeki Parapetler ve Dilatasyonlar için farklı ölçülerde özel olarak imalat yapılmaktadır.

Coping detail for expansion joint application on roofs. It can be produced different dimensions according to parapets width and expansion joint width.

**30-50-100-150-200 mm açıklıklar için.**  
For 30-50-100-150-200mm joint gaps.



### AR606-100K Köşe Dilatasyonu Parapet Birleşimi Harpuşta Detayı AR606-100K Corner Dilatation Detail For Roof

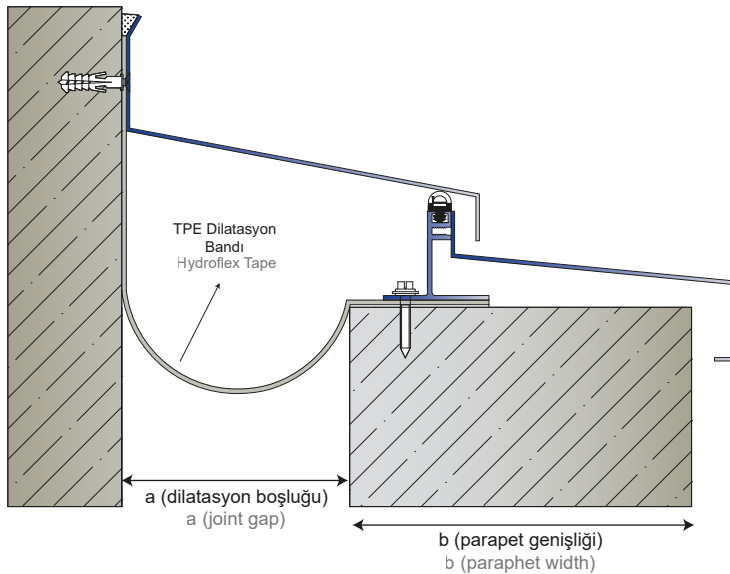

#### AÇIKLAMA / EXPLANATION

Köşe dilatasyonu parapet birleşimi harpuşta detayı.  
Corner dilatation detail for parapet on roof.

**30-50-100-150-200 mm açıklıklar için.**  
For 30-50-100-150-200mm joint gaps.



## TPE Dilatasyon Bandı TPE Dilatation Tape



Hydroflex TPE Dilatasyon Bandı, dilatasyon boşluklarının, ısıl genişleme derzlerinin ve çatlakların yalıtımında kullanılan yüksek elastikiyete sahip dilatasyon bandıdır. Delikli ve deliksiz olarak 150mm,200mm, 250mm,300mm, 400mm genişliklerde 1mm ve 1,50mm kalınlıklarda üretilmektedir.

Highly elastic hydroflex expansion joint tape is used for isolating expansion joint gaps, thermal gaps and cracks on every type of buildings. It is produced 150mm, 200mm, 250mm, 300mm, 400mm width and 1mm,1,5mm thickness with hole and without hole.

### KULLANIM ALANLARI

#### APPLICATION AREA

- Tüm bina dilatasyonlarında , yatay ve dikey uygulamalarda  
Horizontal and vertical application on all type of buildings
- Temellerde ve perdelerde toprak altında kalan kısımlarda  
Foundations and curtain walls.
- Su Yapılarında (Atıksu Arıtma, İçme suyu, Su depoları, Havuzlar)  
Waste water treatment plants, potable water plants, water tanks pools.
- Tünellerde ve menfezlerde  
Tunels and concrete pipes and boxes.
- Radye-Perde, Perde-Perde soğuk derzlerinin su yalıtım uygulamalarında  
Between foundation and curtain wall connection lines.

### ÖZELLİKLERİ ve AVANTAJLARI

#### SPECIFICATION AND ADVANTAGES

- Epoksi yapıştırıcı ile kolay uygulama  
Easy application with epoxy adhesive
- Yüksek elastikiyeye sahip formülasyon ( %600 )  
Special highly elastic chemical formula
- Yüksek yapışma mukavemeti (Kuru veya az nemli betona yapışabilme)  
Good adhesion to concrete, mortar, steel and many other building materials.
- Bitkisel köklere dayanıklı  
Resistant to roots
- Ozona ,mazota ve yağa dayanıklı  
Uv and oil resistants
- Geniş sıcaklık aralığında yüksek performans (-40 ,+90 °C)  
Good performance between wide temperature values
- Isı ile birbirlerine bağlanabilme  
Easy to cut, weld (hot air) and join

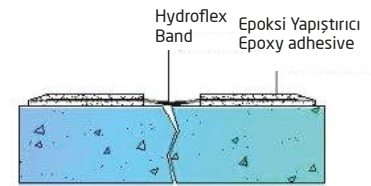
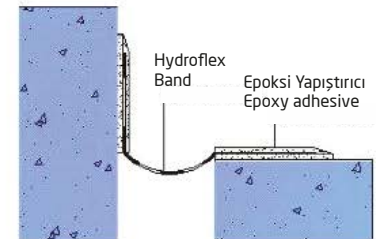
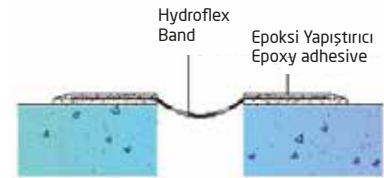

Malzemenin kimyasal özelliği Chemical formulation	TPE (Termoplastik elastomer)
Renk Color	Gri / Grey
Sertlik Shore Hardness	80
Servis sıcaklık değeri Working temperature	-40 / +90 °C
Termik kaynak sıcaklık değeri Welding temperature	270 °C
Kopmada uzama değeri Elongation at break	% 600
Yırtılma dayanımı Shear strength	>600 N/cm
Su basıncı karşısındaki dayanımı Strength of water pressure	>8 bar
Çekme dayanımı Tensile strength	>6 Mpa
UV dayanımı Uv strength	>7500 h
Bitüm dayanımı Resistance to bitumen	İyi / Good
Sülfirik asit dayanımı Resistance to sulphuric acid	İyi / Good
Alkol dayanımı Resistance to alcohol	İyi / Good
Deterjan dayanımı Resistance to detergent	İyi / Good

Genişlik / Width	Kalınlık / Thickness	Boy / Length
15 cm	1 mm & 1,5 mm	25 mt rulo
20 cm	1 mm & 1,5 mm	25 mt rulo
25 cm	1 mm & 1,5 mm	25 mt rulo
30 cm	1 mm & 1,5 mm	25 mt rulo
40 cm	1 mm & 1,5 mm	25 mt rulo





## Epoksi Esaslı Dilatasyon Bandı Yapıştırıcısı Epoxy Based Expansion Joint Adhesive











HYDROFLEX 21, Epoksi esaslı çift bileşenli tamir, ankraj ve yapıştırma harcıdır.

HYDROFLEX 21, is epoxy based repair, anchorage and adhesive mortar with two components.

### KULLANIM ALANLARI APPLICATION AREA

-  Dilatasyon bandının yapıştırılmasında  
Bonding of expansion joint tape
-  Filiz demirlerinin ve civataların ankrajlarında  
Anchoring the rods and bars to the concrete, stone or brick.
-  Geniş çatlakların izolasyonunda ve tamirinde  
Repair and isolating of wide cracks

### ÖZELLİKLERİ ve AVANTAJLARI SPECIFICATION AND ADVANTAGES

-  Yüksek yapışma gücüne sahiptir  
Perfect adhesion to the concrete and steel.
-  Kimyasallara dayanıklıdır  
Resistant to chemicals
-  Solvent içermez  
Solvent free
-  Zemin , duvar , perde ve teras dilatasyonlarında uygulanır  
It can be applied all types of expansion joint gap
-  Su ve gaz geçirimsizdir  
Water and gas impermeable
-  Nemli yüzeylere tatbik edilebilir  
Perfect adhesion to the damp surfaces on concrete
-  Yumuşak kıvamda olup , uygulaması kolaydır  
Easy to apply
-  Astar gereksinimi yoktur  
It doesn't need any primer before application



Malzemenin Bileşen Sayısı Number of components	A ve B olmak üzere 2 bileşenlidir / 2 Component A and B
Malzemenin Kimyasal Özellikleri Chemical Specifications	A Bileşeni: Epoksi Recine A Component: Epoxy Resin B Bileşeni: Epoksi Sertleştirici B Component: Epoxy Hardener
Karışım Oranı - Ağırlıkça A/B Mixed Rate - Weight A/B	5 kg / 1,65 kg 5 kg / 1,65 kg
Karışım Yoğunluğu Mixed Density	1,7 kg/lt 1,7 kg/lt
Servise Açılma Süresi Fully Cured	Yaya ve Hafif Araç Trafığı için : 24 saat Pedestrian usage 24 hours Ağır Yüklerde : 7 gün Fully Cured and Open Service : 7 days
Karışım Ömrü Pot Life	40 dakika (20 °C) 40 minutes (20 °C)
Kuruma Süresi Curing Time	Dokunma : 8-10 saat Recoatable after : 8-10 hours Tam Sertleşme : 1 hafta Fully Cured : 7 days

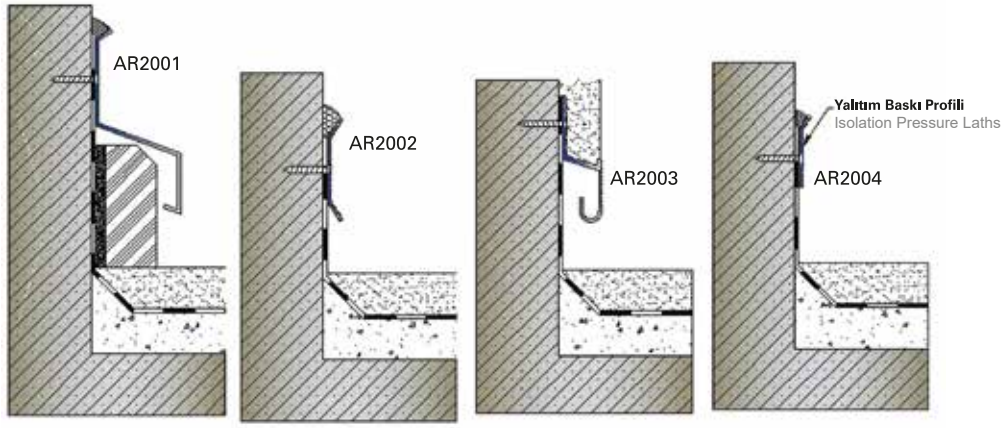

### Yalıtım Baskı Profil Detayları Isolation Pressure Lath Details

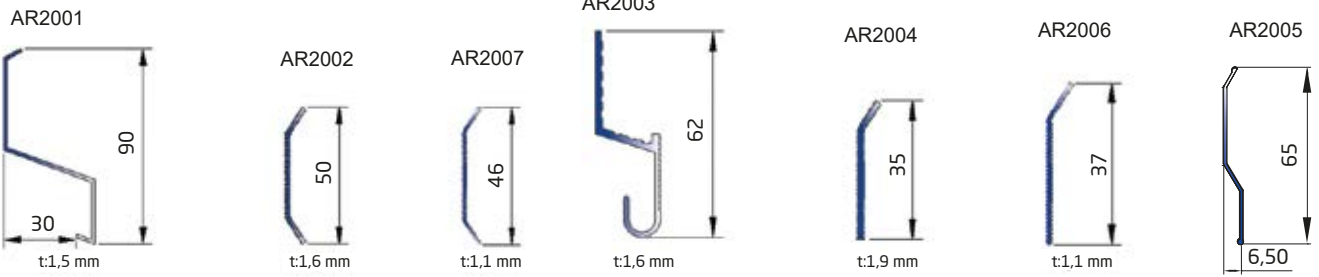

### AR500-100 Dilatasyon Bandı AR500-100 Expansion Joint Tape For Terrace

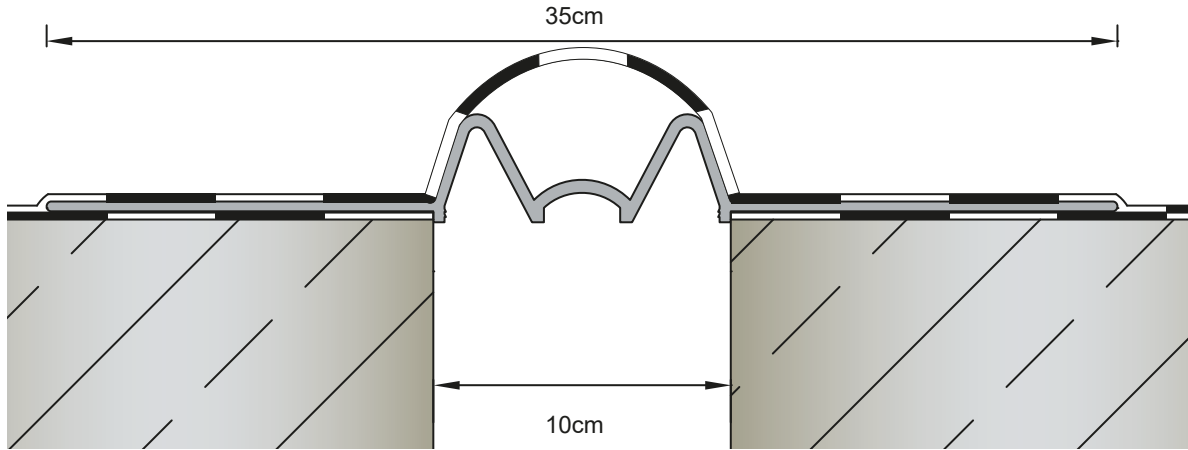

### AR500-030 Dilatasyon Bandı AR500-030 Expansion Joint Tape For Terrace

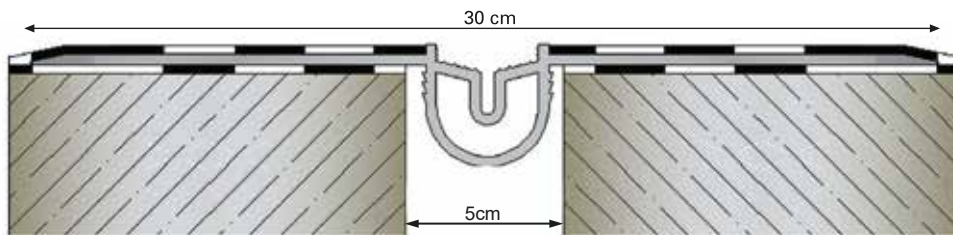

#### AÇIKLAMA / EXPLANATION

Dilatasyonda izolasyon amacı ile kullanılan bitümlü membranla uyumlu termoplastik dilatasyon bandı.  
Renk: Siyah L: 15mt

Thermoplastic dilatation tape that is suitable for bituminous membrane used for isolation purposes in the dilatation gap.  
Colour: Black Roll Length: 15mt

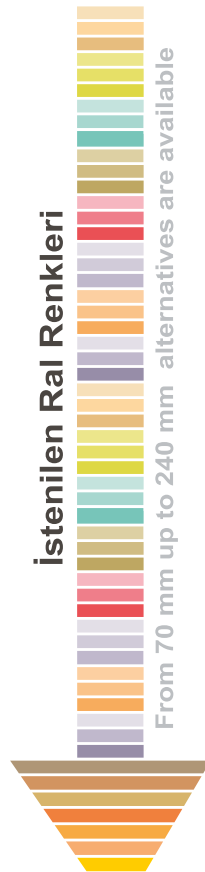
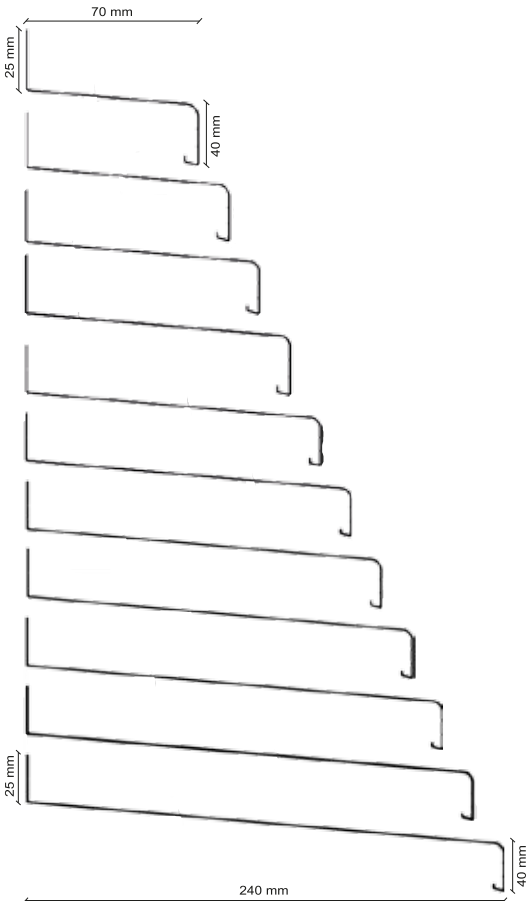

Ürün Kodu Code	Genişlik (W)	Kalınlık (mm)	Yükseklik (H)	Boy (mt)
ARD	70	1,0	25	3,0
ARD	90	1,0	25	3,0
ARD	110	1,1	25	3,0
ARD	130	1,1	25	3,0
ARD	150	1,2	25	3,0
ARD	165	1,3	25	3,0
ARD	180	1,3	25	3,0
ARD	195	1,3	25	3,0
ARD	210	1,4	25	3,0
ARD	225	1,5	25	3,0
ARD	240	1,5	25	3,0

Arfen Denizlik Profilleri, istenilen ral renginde ve değişik ölçülerde üretilirler. Geleneksel denizlik sistemlerine göre daha hafif, dekoratif ve sızdırmazlık detayları çözülmüş sistemlerdir. Özellikle dış cephe ısı yalıtım sistemlerinde kendinden damlalıklı yapısı ile başarı ile uygulanır, işçilik ve taşıma giderlerini azaltır. Ayrıca tasarımcıların farklı renklerde alternatif cepheler oluşturmalarına olanak sağlar.

Arfen WindowSill Profiles, are produced required RAL colors and different dimensions. Compared with conventional systems, Arfen Windowsill is lighter, more decorative and more watertight than others. Especially in exterior insulation on facades, it can be used successfully with dropper structure. It reduces labor costs and transportation costs. In addition, it allows you to create alternative facade with different colors..

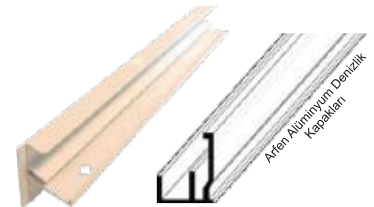
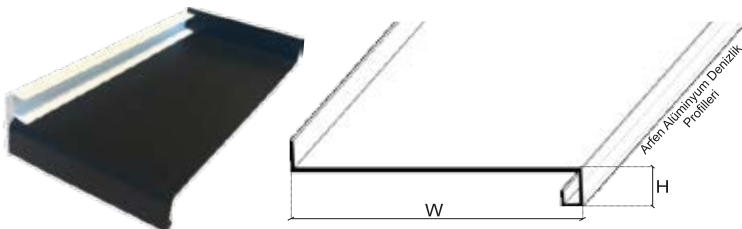



### AR500-01

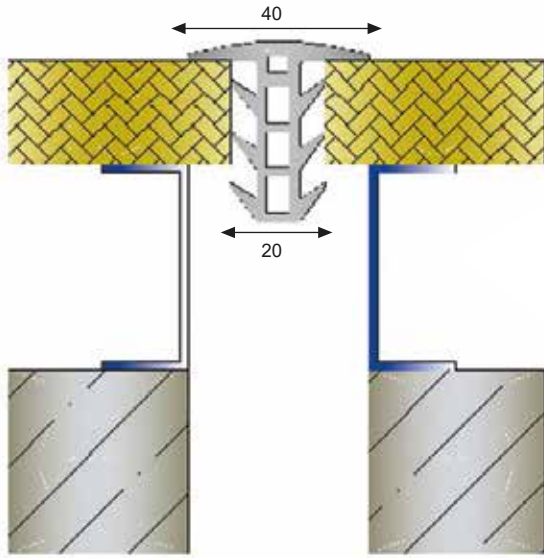

### AR500-02



Fitel Boyu : 25mt.  
Roll Length: 25mt

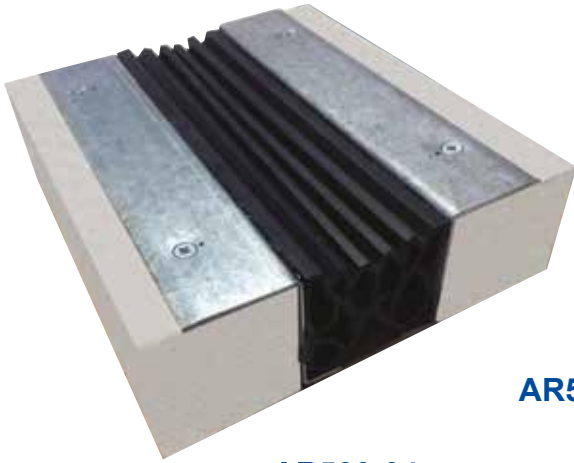

### AR500-06

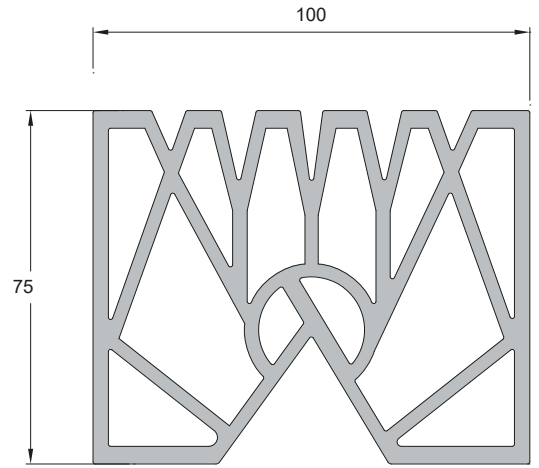

### AR500-05

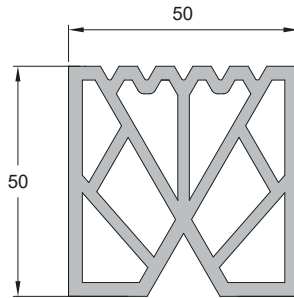

### AR500-04

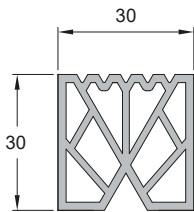

### AR500-03

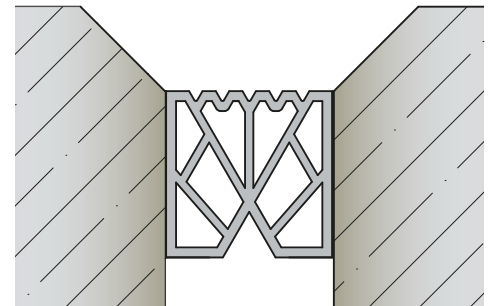
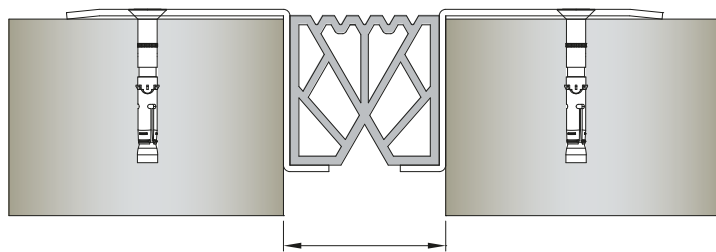
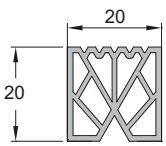

#### AÇIKLAMA / EXPLANATION

Prekast elemanlardaki dilatasyon derzlerinde kullanılır. Yapıştırma amaçlı poliüretan mastik kullanılabilir. Fitel Boyu : 15 mt.  
It is used for pre cast elements. Polyurethane sealant adhesion. Roll Length: 15mt





## YANGIN BARIYERİ

Yangına karşı 2 saat dayanımlı yangın battaniyesidir. Dilatasyon boşluğuna göre değişen ölçülerde yapılan ürünün standart boyu 7 metredir. Özellikle geniş dilatasyon boşluklarında tercih edilir.

## FIRE BARRIER

2 hours providing insulation against fire. According to the dilatation gap ,the products made of various size. The standard length is 7 meters. This solution preferred in large dilatation gap.

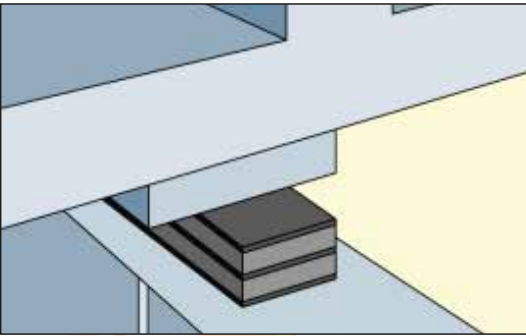

## DERZ DOLGU KÖPÜĞÜ

Yangına karşı 2 saat izolasyon sağlayan, profil şeklinde üretilen yangın izolasyon malzemesidir. Yangın durumunda genişleyerek tam izolasyon sağlar. 2 metre boylarda üretilmektedir.

## GAP SEAL

2 hours providing insulation against fire. This fire insulation material produced in the form of linear profile. Expands in case of fire and provides complete isolation. The standard length is 2 meters.



## TAŞ YÜNÜ

Yangına karşı izolasyon sağlayan taş yününden mamül derz dolgusudur. Dilatasyon boşluğuna göre değişen ölçülerde yapılabilmektedir. Özel yangın spreyi ile birlikte kullanılır.

## ROCKWOOL

Rock-wool joint material that provides insulation against fire. According to the dilatation gap ,the products made of various size. Used with special fire spray.

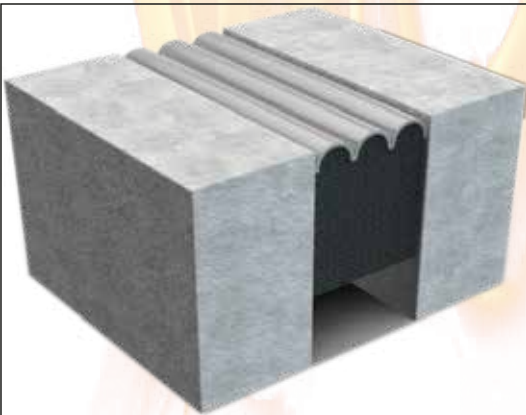

## KÖPÜK & SİLİKON

Yangına ve dumana karşı 3 saat tam izolasyon sağlayan, su geçirmez, ses yalıtımı sağlayan ve 20 yıl UV dayanımı olan sıkıştırılmış köpük ve mastikten üretilen üründür. 2 metre boylarda üretilen ürün sıkıştırılmış halde gelmekte ve epoxy esaslı yapıştırıcı ile derzlere yapıştırılmaktadır.

## FIRE FOAM

3 hours providing insulation against fire. The product also provides water and sound insulation. Compressed foam and sealant products has 20 year UV resistance performance. Manufactured 2 meters length. The products come in compressed form and are glued with an epoxy- based adhesive.

\*Yangın ve duman bariyerlerinin Test raporları ve datasheetleri mevcuttur.

\*Taş yünü dışındaki tüm ürünler İngiltere ve ABD menşeli ürünlerdir.



AJMAN ONE



SHARM EL SHEIKH AIRPORT



FOUR SEASONS HOTEL



RES COMM TOWER



ASGABAT AIRPORT



PLAZA MALL BUCURESTI



KRASNODAR REGIONAL HOSPITAL



BAKU TRUMP TOWER



UPTOWN PROJECT EGYPT



HOLIDAY INN / JEDDAH



SOBHA HARTLAND SCHOOL



ABU DHABI FINANCIAL CENTRE-SOWWAH SQUARE



DUBAI METRO STATION CAR PARK



HUALING HOTEL



NAZARBAYEV UNIVERCITY





TEKFEN TOWER



ECLIPSE MASLAK



VIA PORT VENEZIA



PALLADIUM TOWER



FULYA ACIBADEM HASTANESİ



QUASAR İSTANBUL



KORU FLORYA



MARMARAPARK AVM



MALTEPEPARK AVM

- FOUR WINDS
- 41 BURDA AVM
- 14 BURDA AVM
- POLAT RESIDANCE
- MERTER M1 MEYDAN AVM
- VIALAND
- EYAP TUZLA
- TEPE NAUTILUS
- MALTEPE CARREFOUR
- BAHÇELİEVLER CARREFOUR
- GAZİANTEP ÜNİVERSİTESİ
- MADICAL PARK ANTALYA
- MALL OF İSTANBUL
- GAZİANTEP FORUM AVM
- YTÜ MÜHENDİSLİK FAKÜLTESİ İNŞAATI
- İTÜ KÜTÜPHANE İNŞAATI
- MERCEDES HOŞDERE
- PRINCESS OTEL ORTAKÖY
- KERVANSARAY LARA
- İSTANBUL FORUM AVM
- SEYİDOĞLU FABRİKA İNŞAATI
- IKEA BAYRAMPAŞA
- ANTALYA REAL
- THE MARMARA OTEL
- BARUT OTEL LARA
- ŞİŞLİ ELİT 2000
- MERSİN FORUM AVM
- GÜLLÜOĞLU FABRİKA İNŞAATI
- RESINEX TUZLA
- KAYA MİLENYUM İŞ MERKEZİ
- 212 AVM
- 25 ÜLKEDE ÇOK SAYIDA PROJE

-MEB, SAĞLIK BAKANLIĞI, ADALET BAKANLIĞI,  
TOKİ, ULAŞTIRMA BAKANLIĞI VB. GİBİ KURUMLARIN  
SAYISIZ PROJELERİ....



MALL OF İSTANBUL



ISO 9001:2008



Çözüm Üretir / Produces Solution



**ARFEN İNŞAAT TAAHHÜT SAN. ve TİC. LTD. ŞTİ.**

Atatürk San. Bölgesi Ömerli Mah. Hakkı İleri Cad. Gülce Sk. No: 22 Hadımköy - Arnavutköy / İSTANBUL

Tel : +90 212 485 16 15 Fax : +90 212 485 16 77

www.arfen.com www.dilatasyon.com arfen@arfen.com

İZMİR BÖLGE MÜDÜRLÜĞÜ: +90 232 459 72 71

ANKARA BÖLGE MÜDÜRLÜĞÜ :+90 312 286 00 06